

**Timberdale Ranch  
Community Wildfire Protection Plan  
July 2012**



Prepared for:  
Timberdale Ranch  
Homeowners Association  
Durango, Colorado 81301  
and  
Upper Pine River Fire Protection District

Prepared by:  
Short Forestry, LLC  
9582 Road 35.4  
Mancos, Colorado 81328

# Table of Contents

<b>1. INTRODUCTION.....</b>	<b>1</b>
<b>2. BACKGROUND .....</b>	<b>1</b>
<b>A. Location.....</b>	<b>1</b>
<b>B. Community .....</b>	<b>1</b>
<b>C. Local Fire History .....</b>	<b>2</b>
<b>D. Recent Wildfire Preparedness Activities .....</b>	<b>3</b>
<b>3. PLAN AREA .....</b>	<b>3</b>
<b>A. Boundaries .....</b>	<b>3</b>
<b>B. Private Land Characteristics .....</b>	<b>4</b>
<b>C. Public Land Characteristics.....</b>	<b>5</b>
<b>D. Fire Protection.....</b>	<b>5</b>
<b>4. PLANNING PARTNERS AND PROCESS.....</b>	<b>5</b>
<b>A. Partners.....</b>	<b>5</b>
<b>B. Process .....</b>	<b>6</b>
<b>C. Desired Future Condition.....</b>	<b>6</b>
<b>5. POLICIES .....</b>	<b>7</b>
<b>A. Federal.....</b>	<b>7</b>
<b>B. State .....</b>	<b>7</b>
<b>C. Consolidated County Annual Operating Plan.....</b>	<b>8</b>
<b>D. USFS and BLM Land and Resource Management Plan / Fire Management Plan.....</b>	<b>8</b>
<b>E. La Plata County CWPP.....</b>	<b>8</b>
<b>F. Timberdale Ranch.....</b>	<b>9</b>
<b>6. RESOURCE ASSESSMENT AND TRENDS.....</b>	<b>10</b>
<b>A. Fuels and Fire Hazard .....</b>	<b>10</b>
<b>1. Cover Types.....</b>	<b>10</b>
<b>3. Slash Treatment .....</b>	<b>12</b>
<b>4. Structural Vulnerability.....</b>	<b>12</b>
<b>B. Values At Risk .....</b>	<b>13</b>
<b>1. Socio/Economic .....</b>	<b>13</b>
<b>2. Ecological.....</b>	<b>13</b>
<b>C. Protection Capability.....</b>	<b>13</b>
<b>7. MITIGATION ACTION PLAN.....</b>	<b>15</b>
<b>A. Education and Community Outreach.....</b>	<b>15</b>
<b>B. Policy .....</b>	<b>15</b>
<b>C. Wildfire Mitigation Activities .....</b>	<b>15</b>
<b>1. Vegetation/Fuels Management .....</b>	<b>15</b>
<b>2. Structural Vulnerability.....</b>	<b>17</b>
<b>3. Safety.....</b>	<b>18</b>
<b>4. Specific Activity Recommendations and Priorities.....</b>	<b>18</b>
<b>8. MONITORING AND EVALUATION .....</b>	<b>19</b>
<b>9. GLOSSARY.....</b>	<b>20</b>
<b>10. LITERATURE CITED .....</b>	<b>22</b>
<b>APPENDICES.....</b>	<b>23</b>

# 1. INTRODUCTION

Community Wildfire Protection Plans are authorized by the Healthy Forests Restoration Act (HFRA) of 2003. HFRA places renewed emphasis on local community wildfire protection and response planning by extending a variety of benefits to communities with a wildfire protection plan in place. Among the benefits are the abilities to participate in establishment of fuels treatment priorities for both federal and non-federal lands surrounding communities, establishment of a local definition and boundary for the Wildland-Urban Interface (WUI), and enhanced opportunities for cost-sharing of community-based fuels treatments.

The Timberdale Ranch Homeowners Association has recognized that the subdivision is at risk from wildfires moving into or originating within the subdivision. A local effort to educate homeowners and develop defensible space has been underway for several years in conjunction with the Upper Pine River Fire Protection District (UPRFPD). Development of a Community Wildfire Protection Plan (CWPP) for Timberdale Ranch is the next step in that effort.

## 2. BACKGROUND

### A. Location

This CWPP covers the Timberdale Ranch subdivision and its defined WUI. Timberdale Ranch is located in La Plata County in southwest Colorado, approximately 6 miles northwest of Bayfield at the north end of County Road 504. Elevations of the subdivision range between 7450 and 7880 feet.

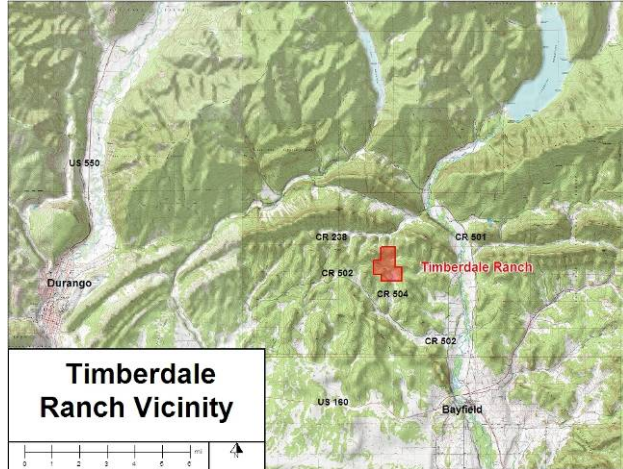

### B. Community

Timberdale Ranch is a 585-acre subdivision with 80 lots owned by individuals, eight lots owned by Skystone Owners Association and Subdivision residents should be offered a general emergency situation safety awareness session annually to update emergency communication trees, evacuation routes and gathering points seven lots or common areas owned by the Chimney Ranch or Timberdale Ranch Owners Association. There are 68 residences plus the caretaker structure at present. The subdivision was initiated in 1972 as Chimney Ranch and was renamed Timberdale Ranch in 1984. The residences are single-

family structures with exterior finishes ranging from wood or hardboard siding to logs to stucco. Roof coverings are generally metal or asphalt shingle. Many have wood decks and porches. The water supply for the subdivision comes from individual wells. The subdivision is accessed from County Road 504, which ends at the subdivision's entrance.

Timberdale Ranch is located in a ponderosa pine/Gambel oak forest. A characteristic of the subdivision is the retention of the native trees and shrubs during construction of the residences. The overall context is rural. Some homes have small irrigated yard areas, but many have native vegetation right up to the residence.

The wildlife present in the area includes all the species expected in the lower montane areas of the central Rocky Mountains. Mule deer (*Odocoileus hemionus*), elk (*Cervus elaphus*), black bear (*Ursus americanus*), cougar (*Felis concolor*), coyote (*Canis latrans*), porcupine (*Erethizon dorsatum*), skunk (*Spilogale spp*), and piñon mouse (*Peromyscus truei*) are some of the mammalian species. Merriam's turkey (*Meleagris gallopavo merriami*), common raven (*Corvus corax*), golden eagle (*Aquila chrysaetos*), red-tailed hawk (*Buteo jamaicensis*), horned owl (*Bubo virginianus*), mountain and western bluebirds (*Sialia currucoides* and *S. Mexicana*), downy woodpecker (*Picoides pubescens*), white-breasted nuthatch (*Sitta carolinensis*), and mountain chickadee (*Parus Gambeli*) are some of the avian species. No US Fish and Wildlife Service listed "Threatened" or "Endangered" species are known to inhabit the subdivision.

Slopes range from 0 to 30% across the subdivision. Average gradient from south to north is +7% and east to west is +6%. Slope shapes are convex. Aspect is generally south-southeast.

Annual precipitation for the subdivision is approximately 25 inches, with the wettest months being July, August and September. May and June are relatively dry, with a summer "monsoon" in July and August (source: Western Regional Climate Center). Early monsoonal storms are often characterized by dry thunderstorms with lightning and strong, variable outflow winds. The largest wildfires in the past 20 years in La Plata County have occurred from early June into early August.

### **C. Local Fire History**

The 76,000-acre Missionary Ridge Fire burned to within five miles of the subdivision in 2002. Other large wildfires have occurred in La Plata County over the past twenty years. Examples include the Black Ridge Fire (1994) that burned over 10,000 acres in piñon/juniper approximately 25 miles southwest of the subdivision; the Sambrito 2 Fire (2011) that burned 500 acres of ponderosa pine and piñon/juniper 20 miles southeast of the subdivision; and the Red Creek Fire that burned approximately 45 acres of mixed conifer forest six miles northwest of

Timberdale in 2010. Lightning scars are apparent on trees across the subdivision, so lightning fires are possible and have likely occurred in the past. None have burned any significant acreage or caused damage to structures since Timberdale originated in 1984. The last large fire in the subdivision area was documented in 1888.

#### **D. Recent Wildfire Preparedness Activities**

1. Included FireWise educational presentations and information at community meetings.
2. A 1-acre demonstration fuels reduction project thinning ponderosa pine and Gambel oak in conjunction with the UPRFPD and FireWise Council of Southwest Colorado.
3. A 5-acre common space area was prescribed burned in 2011.
4. A member of the HOA board is a FireWise Ambassador for the subdivision.

### **3. PLAN AREA**

#### **A. Boundaries**

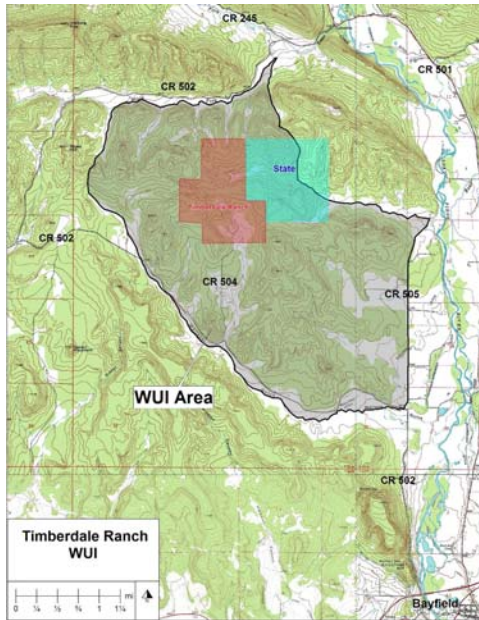

The CWPP covering the WUI area was developed collaboratively with the Timberdale Ranch HOA, subdivision residents, the Colorado State Forest Service, La Plata County Office of Emergency Management, Upper Pine River Fire Protection District, FireWise of Southwest Colorado, the San Juan National Forest and the Bureau of Land Management. The WUI area is based on the area centered on the subdivision likely to burn in high fire danger conditions during a single burning period if pushed by 20 mph winds.

The WUI boundaries are from the intersection of CR 502 and 505 north along CR 505 to the tributary to the Los Pinos River south of the east end of Vosburg Pike, then east-northeast up the tributary to the top of the divide and then northwest down the first drainage from the mouth of the South Fork of Texas Creek, then east along the South Fork to the tributary just east of Rules Hill, then south across

Rules Hill to the headwater of Wallace Gulch, then southeast along Wallace Gulch to the beginning point.

Total WUI area is 6,160 acres and is shown on the **Timberdale Ranch WUI** map above and in Appendix A. Private land in the WUI covers 5,710 acres. Colorado State lands cover 450 acres.

## **B. Private Land Characteristics**

The 5,710 acres of private land within the WUI boundary includes the 585-acre Timberdale Ranch subdivision plus 157 parcels outside the subdivision. Parcel sizes range from approximately 0.1 acre to over 400 acres. Many of the private parcels outside Timberdale Ranch have residences or other structures on them. Land uses are generally residential, agricultural (pasture and hay production), oil and gas production well pads and non-industrial small business.

The vegetation type is primarily ponderosa pine/ Gambel oak forestland. The forest stands are dominated by ponderosa pine (*Pinus ponderosae*), with small components of Douglas-fir (*Pseudotsuga menziesii*), white fir (*Abies concolor*), blue spruce (*Picea pungens*) and aspen (*Populus tremuloides*).

Montane shrubs include Gambel oak (*Quercus gambelii*), mountain mahogany (*Cercocarpus montanus*), shrubby cinquefoil (*Pentaphylloides floribunda*) and serviceberry (*Amelanchier spp.*).

There are six meadow areas with both native grasses and introduced species like bluegrass (*Poa spp.*). Native grass species include sedges (*Caryx spp.*), little bluestem (*Schizachyrium scoparium*), Arizona fescue (*Festuca arizonica*) and slender wheatgrass (*Agropyron trachycuum*).

The vegetation cover types in the subdivision can be summarized in three community groups. Cover types are summarized in the following table.

<b>Cover Type</b>	<b>Area</b>	<b>Area Percent</b>
Ponderosa Pine	425 acres	73%
Montane Shrub	89 acres	15%
Grass	71 acres	12%

Fuel Models associated with the cover types are discussed in Section 6: Resource Assessments and Trends. The cover types are shown on the **Timberdale Ranch Cover Type** map in Appendix A.

Private lands outside the subdivision within the WUI area have similar cover types and fuel models.

### **C. Public Land Characteristics**

Public lands in the WUI consist of 450 acres of State lands immediately to the east of the subdivision. Vegetative cover includes grass and forbs, ponderosa pine, Gambel oak, mountain mahogany and other montane shrubs and scattered piñon pine and Rocky Mountain juniper on exposed south and west slopes. Fuel models are the same as those in the same cover types on private lands.

### **D. Fire Protection**

Structural and wildland fire protection is provided by the Upper Pine River Fire Protection District. Both structural and wildland fire engines are resources available through the Fire Protection District. Other wildland fire resources are available through Durango Interagency Dispatch Center. Wildland fire resources include engines and crews from the US Forest Service, Bureau of Land Management, Mesa Verde National Park, Colorado State Forest Service, Bureau of Indian Affairs and the Southern Ute and Ute Mountain Ute Tribes. An air tanker base is located at Durango - La Plata Regional Airport and additional aerial wildfire support can be provided by the Mesa Verde National Park initial attack helicopter at Hesperus, the Ute Mountain Ute initial attack helicopter at Towaoc and the Colorado State Forest Service Single Engine Air Tanker at Cortez. The Counties, Federal land management agencies, Colorado State Forest Service and Fire Protection Districts in Southwest Colorado operate under a Consolidated County Annual Operating Plan (AOP) for wildfire protection.

## **4. PLANNING PARTNERS AND PROCESS**

### **A. Partners**

The HOA has received process and planning assistance and input from the following individuals and organizations:

Rich Graeber, Chief, Upper Pine River Fire Protection District  
Kent Grant, Durango District Forester, Colorado State Forest Service  
Craig Goodell, San Juan Public Lands Mitigation and Education Specialist  
Pam Wilson, FireWise Council of Southwest Colorado  
Butch Knowlton, La Plata County Emergency Manager  
Jim Tencza, homeowner, HOA board member and FireWise Ambassador  
Timberdale Ranch Homeowners Association Board  
Bruce Short, Short Forestry LLC, forest and fire management consultant

## **B. Process**

A Core Team was assembled including representatives from the Colorado State Forest Service, San Juan Public Lands Center, Upper Pine River Fire Protection District, La Plata County Office of Emergency Management, the FireWise Council of Southwest Colorado and the FireWise Ambassador for Timberdale Ranch. The Team met in September 2011 with the FireWise Ambassador and developed an initial list of issues and concerns that the CWPP should address. A field trip to the subdivision by the Core Team occurred in January 2012. A meeting to discuss the CWPP process and recommendations was held with residents in April 2012 and a draft CWPP was presented to the HOA board and interested residents in June 2012.

One of the Team members is a FireWise Ambassador for the subdivision. He attends the FireWise Council of Southwest Colorado meetings regularly and brings back FireWise information to the HOA members at their regularly scheduled meetings.

## **C. Desired Future Condition**

The Desired Future Condition (DFC) for Timberdale Ranch has been developed through the collaborative CWPP process. The DFC is:

*Timberdale Ranch is a desirable, rural forested community safer from catastrophic wildfire moving into or through the community. Homes are less vulnerable to wildfire by the use of fire-resistant construction methods and FireWise landscaping. Fuels within 100 feet of residences are maintained at levels which would support only low intensity surface fires, while fuels in the remainder of the landscape in the subdivision would support low to moderate intensity wildfire.*



## **5. POLICIES**

### **A. Federal**

The Timberdale Ranch CWPP has been developed in response to the Healthy Forests Restoration Act of 2003 (HFRA). This legislation established unprecedented incentives for communities to develop comprehensive wildfire protection plans in a collaborative, inclusive process. Furthermore, this legislation directs the Departments of Interior and Agriculture to address local community priorities in fuel reduction treatments, on both federal and non-federal lands.

The HFRA emphasizes the need for federal agencies to collaborate with communities in developing hazardous fuel reduction projects and places priority on treatment areas identified by communities themselves through development of a Community Wildfire Protection Plan (CWPP). Priority areas include the wildland-urban interface (WUI), municipal watersheds, areas impacted by windthrow or insect or disease epidemics, and critical wildlife habitat that would be negatively impacted by a catastrophic wildfire. In compliance with Title 1 of the HFRA, the CWPP requires agreement among local government, local fire departments, and the state agency responsible for forest management i.e., the Colorado State Forest Service. The CWPP must also be developed in consultation with interested parties and the applicable federal agencies managing public lands surrounding the at-risk communities.

### **B. State**

The State of Colorado is concerned about the size and intensity of wildfires occurring across the state in recent years. The State Legislature enacted House Bill 1110 in 2008, creating a five-year program running from 2009 to 2014 that allows landowners to deduct a portion of the actual costs of their wildfire mitigation from their state income tax. The program allows each landowner to get credit for fifty percent of the cost of wildfire mitigation up to a total of \$2,500. To get the full credit the total mitigation costs must be \$5,000 or greater. The work must be done in accord with an existing Community Wildfire Protection Plan to qualify.

The Colorado State Forest Service conducted a Statewide Forest Resource Assessment and released a Statewide Forest Resource Strategy in 2010. One of the themes for the Assessment and Strategy is “Protect Forests from Harm.” The identified threats relevant to Timberdale Ranch are:

- Wildfire in the Wildland-Urban Interface.
- Insects and Diseases Affecting Community Forests

The area around the subdivision has been identified as having High Wildfire Susceptibility based on weather, historic fire occurrence, topography, surface fuels and canopy closure.

The applicable strategies identified to address the threats are:

- Focus forest management activities to reduce impacts of wildfire, and forest insects and diseases.
- Coordinate forest management implementation among all parties affected by the CWPP.
- Advocate landscape approaches to protect communities.
- Collaborate with land management agencies, fire protection districts and insurance organizations to develop improved standards that lead to protection of homes in the WUI.
- Expand the use of the Good Neighbor Authority in Colorado.

### **C. Consolidated County Annual Operating Plan**

The Counties, Federal land management agencies, Colorado State Forest Service and Fire Protection Districts in Southwest Colorado operate under a Consolidated County Annual Operating Plan (AOP) for wildfire protection. This plan provides for mutual aid to assist with the management of wildfire incidents in southwest Colorado. The plan for mutual aid provides significantly enhanced initial and extended attack capabilities through the rapid convening of fire protection resources for managing a wildfire. The Consolidated County AOP outlines standard operating procedures and the level of participation and available resources of each party under the plan.

### **D. USFS and BLM Land and Resource Management Plan / Fire Management Plan**

The San Juan National Forest and Tres Rios (previously San Juan) Bureau of Land Management Resource Area Land and Resource Management Plans and associated Fire Management Plans describe the role of fire in the native ecosystems in southwest Colorado. These plans outline the strategies that the USFS and BLM will utilize to manage wildland fire and fuels on these federal lands in southwest Colorado. The San Juan National Forest and San Juan Resource Area Fire Management Plan (2007) specifically describes objectives and strategies to manage fire and fuels on federal lands near communities within the wildland-urban interface.

### **E. La Plata County CWPP**

The Timberdale Ranch CWPP tiers to the La Plata County CWPP approved in July 2006. This plan is consistent with the goals and strategies described within the La Plata County CWPP and provides further strategic and tactical direction specific to wildfire protection and mitigation for the Timberdale community.

## **F. Timberdale Ranch**

The subdivision covenants were adopted March 12, 1984. Article III, Section 3; Trees and Landscaping states in part “No trees or perennial bushes, except for Colorado Oak, exceeding twelve (12) feet in height may be cut or removed...except by written approval by the Architectural Standards Committee.”

Article III, Section 11; Firefighting Systems states “(W)hen a residence is constructed on any lot, there shall be installed on such lot a water storage reservoir of at least 1,000 gallons to be used as a water reservoir for firefighting purposes and meeting the requirements of the Architectural Standards Committee. The water storage reservoir shall be properly equipped to allow its use for firefighting purposes.” This covenant has not been enforced and so no individual residence has such a reservoir.

## 6. RESOURCE ASSESSMENT AND TRENDS

### A. Fuels and Fire Hazard

#### 1. Cover Types

The ponderosa pine cover type is approximately 130 years old, reflecting the extensive timber harvests occurring in the lower elevations of La Plata County in the late 1800's and early 1900's. Stand densities range from 60 to 200+ square feet of basal area per acre and average approximately 120 square feet per acre.

That density is more than is desirable for good forest health. Infestation risk from mountain pine beetle (*Dendroctonus ponderosae*) increases above stand densities of 80 square feet per acre as does the risk of crown fire. Gambel oak and other shrubs under the mature trees are often present, serving as ladder fuel to the low tree canopies.



Montane shrubs are primarily Gambel oak, with densities

*Ponderosa Pine, Gambel Oak and Grass*

up to 1000 stems per acre. The oak is present as both discreet clumps and as more widespread understories under the ponderosa pine. Scattered piñon pine (*Pinus edulis*) and Rocky Mountain juniper (*Juniperus scopulorum*) are also present on the steeper, drier sites in the northern part of the subdivision.

The grass cover type consists of former pastureland in the southern part of the subdivision and grassed drainage bottoms in the northern part. If irrigated during the growing season the former pastures could act as a fuel break for wildfires.

#### 2. Fuel Models

The La Plata County CWPP (2006) shows the area of Timberdale Ranch as a “higher” level of concern on the La Plata County Fire Risk Zone Map due to the cover types and fuel loads typically present.

The major Fuel Models present across the subdivision by cover type are:

Cover Type	NFFL Model (Anderson, 1982)	Standard Fire Behavior Models (Scott and Burgan, 2005)
Ponderosa Pine/Mixed Conifer	9	TU5
Montane Shrub	6	SH2
Grass	1	GR1

**Closed Canopy Long-Needled Conifer (NFFL 9/Standard Fire Behavior TU5):** This model is for the closed canopy ponderosa pine cover type with moderate downed woody fuels and shrub components. Flame lengths and spread rates are moderate. Interlocking tree crowns and the presence of concentrations of fuels coupled with low fuel moisture, low humidities, high temperatures and moderate to high winds can increase spread rates and intensities and move fire into the tree crowns.



*Model 9 / TU5*

**Montane Shrub (NFFL 6/Standard Fire Behavior SH2):** This model includes the Gambel oak with scattered piñon/juniper cover type. Fires carry through the shrub layer as well as the cured litter and dead woody material on the ground surface with moderate (greater than 8 miles/hour eye-level) winds. Lighter winds and openings in the canopy will drop the fire to the surface. Intensity and



*Models 6 / SH2 foreground and 1 / GR1 mid-ground*

duration can be moderate to high. A complicating factor for this fuel model is the level of standing and down dead wood present due to past frost-kill in the oak and the *Ips* outbreak in the early 2000's. Down woody fuels exceed 25 tons per acre in some locations and loads in excess of 10 tons per acre are common. Normal live and dead fuel loads in Fuel Model 6 are 6 tons per acre.

**Short Grass (NFFL 1/ Standard Fire Behavior GR1):** This model includes both native grass and agricultural pasture cover types. Fire spread is governed by the fine and continuous herbaceous material that is cured or nearly so. Fire will not readily spread when relative humidity is over 25%. Fires are surface fires that move rapidly through the cured grass and associated litter. Fires can be intense if fuels are very dry but fire duration is usually short.

### **3. Slash Treatment**

Effective reduction of slash created by fuels mitigation is an important aspect of a fuels mitigation program. Piling and burning of slash is an effective treatment but usually requires snow cover or very moist conditions. Broadcast burning is also effective and more ecologically desirable since it can increase soil nutrients and provide good establishment conditions for desirable vegetation. However, broadcast burning requires a high level of technical expertise to accomplish and the smoke generated can negatively affect people with respiratory issues. There are residents at the present time that have the technical expertise to implement broadcast burns.

Chipping slash is an alternative to piling and burning but it can generate large chip piles that stay for years or chip depths across the landscape which can be a fire hazard in themselves in dry years.

### **4. Structural Vulnerability**

Residential structure ignitability is low to moderate. Wood is the predominant siding material for the residences. There are sheds and outbuildings, fences, porches and decks of wood construction. Roofing is most often metal "propanel" type material with less use of asphalt shingles. The major vulnerability issues are flammable vegetation and pine needle litter in close proximity to the structures.

Access is generally good along the road system but signage visibility is poor at some intersections. Some driveways to residences are narrow or steep and have limited turn-around areas for structure fire engines.

Zone 1 (zero to 15 feet from structures) around most residences is good, with limited flammable fuels. Zone 2 (15 to 75 feet from structures) is variable, with some homes having irrigated lawns and wide spacing between trees and shrubs. Others have extensive areas of trees with interlocking crowns up to the home and a lot of pine straw on the ground. With some exceptions Zone 3 (75 feet or more from structures) in the subdivision has received little management over the last 25 years.

## **B. Values At Risk**

### **1. Socio/Economic**

The forested setting of the subdivision is valued by its residents. House pets and horses are common. Timberdale Ranch is a moderate-cost subdivision close to Durango so the location is prized by its residents.

### **2. Ecological**

The setting of Timberdale Ranch is wooded, so loss of the trees from wildfire would have a significant impact to the ambiance of the community, even if no structures were lost. No threatened or endangered species are known to inhabit the subdivision itself, but rare plants may occur within the WUI area.

Southwest Colorado is noted for its good air quality. Wildfire would negatively affect the air quality of the area during a fire.

Wildfire can adversely affect soil quality, reducing water permeability, increasing bulk density and removing organic matter. The soils in the subdivision are sedimentary with moderate erodibility and moderate fertility. Loss of tree cover due to a severe wildfire would increase susceptibility to erosion.

The subdivision is located in the Los Pinos River watershed. Water originating from the watershed flows into Navajo Lake and the San Juan River, and then into the Colorado River. Introduction of soot and sediment due to a wildfire within the watershed could compromise water quality in Navajo Lake and the Colorado River.

Ecosystem health for the WUI is fair. Density of the ponderosa pine component and suppression of small fires over the past 100 years has increased the downed woody fuels across the WUI area as well as needle and leaf litter depths. Fuels management has occurred on several lots in the subdivision over the past five years but many have not had any treatments.

## **C. Protection Capability**

The subdivision is served by the Upper Pine River Fire Protection District. The District is staffed by both full-time staff and volunteer firefighters. There is a seasonal wildfire crew which has National Wildfire Coordinating Group (NWCG) wildland firefighting qualifications. The main fire station is located on the west side of the town of Bayfield along County Road 501 and there are several substations across the Fire Protection District. U.S. Forest Service and Bureau of Land Management fire crews and aerial wildfire support by the Mesa Verde National Park initial attack helicopter at Hesperus and the Ute Mountain Ute initial attack helicopter at Towaoc are available under the mutual aid agreement.

Wildland fires occurring on private lands are generally managed for full suppression. Wildfires on National Forest and BLM-managed public lands and Tribal lands in La Plata County are managed with policies that may involve full suppression, point suppression, confinement or containment strategies.

Water is supplied from individual wells, so there is no hydrant system for either structural or wildland fires. In wet years, a pond in the south-central area of the subdivision exists, but it is a meadow in dry years. The subdivision covenants specify that residences constructed from 1984 on have a 1000-gallon reservoir for firefighting, but that covenant has not been enforced.

Evacuation of Timberdale Ranch in an emergency is facilitated by a second emergency access with a key-coded gate at the north end of the subdivision. This road accesses CR 502 approximately two miles west of its intersection with CR 501. The primary public entrance is at the south end onto CR 504. Evacuation actions are the responsibility of the La Plata County Sheriff's Office and the La Plata County Emergency Manager.



## **7. MITIGATION ACTION PLAN**

### **A. Education and Community Outreach**

The audience for the Mitigation Action Plan includes the residents of Timberdale Ranch, landowners immediately surrounding the subdivision that can benefit from mitigation activities on their properties and in the subdivision; government agencies planning complementary mitigation treatments and/or supplying grants or matching funds to perform mitigation; and emergency responders.

Outreach methods may include:

- Educational information at scheduled community meetings.
- Educational community workshops which could include subdivision residents and other community members sponsored by the FireWise Council of Southwest Colorado and/or the Upper Pine River Fire Protection District.
- FireWise Committee information mailed to all residents.
- Ensure landowners are aware of the state tax incentive for wildfire hazard mitigation (House Bill 1110).
- Periodic sponsored fuels treatment events with the residents sharing expertise and equipment.
- Awareness training on basic wildfire initial attack for interested subdivision residents.

### **B. Policy**

Authority and responsibility for managing vegetation on private property within Timberdale Ranch rests with the residents.

### **C. Wildfire Mitigation Activities**

#### **1. Vegetation/Fuels Management**

The tree cover across the subdivision is ponderosa pine with shrub and small tree understories. Tree stocking is generally over-dense so recommended treatments are aimed at reducing density and removing ladder fuels to reduce the opportunity for crown fires in close proximity to the residences. The recommendations are consistent with *Creating Wildfire-Defensible Zones* (Dennis 1999a).

Flammable trees or shrubs are discouraged within 15 feet of residences (Zone 1). If desirable trees or shrubs are in this area, dead branches, stems and leaf litter should be removed and the zone extended accordingly. Tree branches should be pruned up at least 10 feet above ground. Xeriscaping landscaping techniques using plants and materials with low flammability can reduce the risk of flames adjacent to structures. It is recommended that landscaping within 3-5 feet of structures consist of gravel, rock or other non-flammable materials. Wood chips should not be used as mulch under flammable shrubs within Zone 1.



*Demonstration Zone 2 Treatment (Los Ranchitos)*

The Zone 2 area is found within 15 to 100 feet of the residence. Here, trees taller than 15 feet should be thinned to a spacing of 10-20 feet between crowns. Trees selected for retention should generally have at least 50% live crowns. Branches lower than 10 feet from the ground surface should be pruned. Trees shorter than 15 feet tall should be spaced no closer than five feet from the edge of adjacent tree crown edges. Oak clumps should be spaced

no closer than two times shrub height to other clumps or trees. Grasses should be mowed to a maximum of six to eight inches, especially by fall when grasses are dried out.

The Zone 3 area extends from the outer edge of Zone 2 to the individual property boundary. This area should be managed to minimize tree mortality from insects and diseases and reduce the possibility of large-scale, stand-replacement wildfires. Wind-driven crown fires are the primary type of stand-replacement wildfire in ponderosa pine forests, so thinning over-dense clumps to stand densities of 60 to 80 square feet of basal area or no



*Zone 3 Treatment (Durango West 2)*

more than 70 trees over 15 feet tall per acre and reducing downed woody fuels can reduce wildfire risk. Slash from thinning and fuels reduction activities should be chipped or piled for burning when snow is present or soils and vegetation are damp. All juniper trees within 10 feet of ponderosa pine tree crowns in the ponderosa pine type should be removed in the thinning.

The meadow common areas should be grazed or mowed to a stubble height no greater than six to eight inches once grasses cure. This would keep fire intensities low and reduce spread rates if a fire moved across the meadows.

Safety of residents and emergency responders can be enhanced by developing shaded fuelbreaks along all roads passing through forested areas. Again, the prescription would be thinning trees to a density of 60 square feet of basal area per acre or approximately 50 trees per acre. Clumps of oak can be left but should be spaced no closer than 2 times the shrub height. The fuelbreaks should be 50 feet wide from each side of the road running surface. Roads in open meadows should have grass mowed to a six to eight inch height at least 10 feet each side of the running surface.

Probability of wildfire moving into or out of Timberdale Ranch can be reduced through implementation and maintenance of a 100 foot-wide shaded fuelbreak in the forests and woodlands along the subdivision boundary. The treatment prescription would be the same as Zone 2, i.e., crown spacing of 15 to 25 feet between trees, tree clumps or shrub clumps plus pruning of tree branches up 10 feet. Treatment area would cover 36 acres inside the subdivision. An adjacent shaded fuelbreak outside the subdivision is also recommended, totaling 49 acres. The fuelbreaks are shown on the **Timberdale Ranch Treatments** map in Appendix A.

Eradication of cheatgrass (*Bromus tectorum*) is recommended in Zone 1 and eradication or reduction within 30 feet of structures in Zone 2. Cheatgrass is extremely flammable when cured and spreads rapidly after disturbances like construction activity or wildfire. Control recommendations are found in the publication *Cheatgrass and Wildfire* (Davison, Smith and Beck 2007) in Appendix F.

## **2. Structural Vulnerability**

Recent research by Jack Cohen (Missoula Fire Science Laboratory) has shown that most homes catch fire from flying embers, not from the flaming fire front. When building and/or remodeling, residents are strongly encourage to consider using fire-resistant materials and follow construction guidelines.

Structure construction using unpainted rough wood products including wood shake roof shingles is discouraged since those materials are very receptive to sparks and flame. Roof materials such as metal, cement or cement-fiber shingles and tile are not receptive to sparks, flame and heat. Enclosing soffits with 1/8" metal screening also discourages ignition of roofs and eaves. Detailed fire-resistant construction guidelines are found in *Firewise Construction, Design and Materials* (Slack 1999) in Appendix G.

Locate woodpiles and propane tanks at least 30 feet from structures. Clear flammable vegetation at least 10 feet away from woodpiles and tanks.

Enclose the underside of wood decks and porches so that embers and flames cannot get underneath them. Keep grass or weeds from growing under them.

Structural protection can be enhanced by providing cisterns for drafting by engines. This would greatly reduce turn-around times for engines and allow for multi-structure protection. Cisterns could be installed on the common space areas close to the road system. Upper Pine River Fire Protection District has agreed to provide plumbing assistance.

### 3. Safety

The HOA should work with the La Plata County Emergency Manager to develop an Emergency Evacuation Plan for the subdivision. The plan should include wildland fire safety zone locations, standard evacuee assembly points, communication trees and management action points.

Wildland fire behavior, suppression tactics and firefighter safety awareness training should be made available to interested subdivision residents who could be called on for initial attack.

Subdivision residents should be offered a general emergency situation safety awareness session annually to update emergency communication trees, evacuation routes and gathering points.

### 4. Specific Activity Recommendations and Priorities

The following mitigation activity and treatment recommendations are listed by priority for the Timberdale Ranch HOA, the residents and lot owners of Timberdale Ranch, Upper Pine River Fire Protection District and adjoining landowners and cooperators.

Group	Priority	Activity/Action	Estimated Cost	Activity Period
HOA	10	Provide basic initial attack wildland firefighting awareness training (similar to S110, S130, S190) to interested residents.	\$500	2012 - 2017
HOA	6	Develop a subdivision emergency notification and evacuation plan in consultation with Upper Pine River FPD, La Plata County Emergency Manager and the subdivision residents. The plan would include livestock care protocols, "Safety Zones" where residents could safely shelter-in-place and fire equipment staging areas.	\$5000	2012/ 2013
HOA	11	Modify the subdivision architectural guidelines to encourage forest management, including tree cutting, for forest health and fuels mitigation.	N/A	2013
HOA	1	Develop shaded fuelbreaks 50 feet on either side of subdivision roads (approx.5 miles)	\$90,000	2012 - 2017
HOA	4	Develop a 100 foot-wide shaded fuelbreak along the wooded portions of the subdivision boundary	\$55,500	2013 - 2017
HOA	9	Sponsor annual fuels "clean-up" days for the	\$2000	2012-

		residents	annually	2017
HOA/Home-owners	2	Assist homeowners with individual defensible space creation and fuel mitigation by providing annual information and education programs on effective mitigation techniques.	\$500 annually	2012-2017
Homeowners	3	Thin and prune trees and large shrubs around residences consistent with the recommendations of CSU Publication 6.302 <i>Creating Defensible Space</i> by F.C. Dennis	\$1500 per acre	2012-2017
Homeowners	8	Use of "FireWise" plant materials in landscaping per CSU Publication 6.305 <i>FireWise Plant Materials</i> by F. C. Dennis	Variable	2012-2017
Other Ownerships	5	Work with surrounding landowners to apply shaded fuelbreak treatments to adjoining properties.	\$1500 per acre	2012-2017
HOA	7	Install in-ground or above-ground water tanks for fire-fighting assistance	\$7000	2012-2017

## 8. MONITORING AND EVALUATION

Monitoring and evaluation of outreach, education and mitigation efforts within Timberdale Ranch and its WUI are an important part of the CWPP. The monitoring and evaluation actions for the CWPP are shown below along with the responsible group and when those actions should occur.

<b>Monitoring</b>		
<b>Group</b>	<b>Action</b>	<b>Period</b>
HOA	Annual Report to the Community, FireWise Council of SW Colorado , Colorado State Forest Service	Annually
CSFS	Monitoring of mitigation work status for work covered by grants	As required

<b>Evaluation</b>		
<b>Group</b>	<b>Action</b>	<b>Period</b>
HOA	Annual Report will list "Lessons Learned" from fuels mitigation projects and activities over the preceding year.	Annually
HOA	Review CWPP and measure progress by degree of accomplishment of mitigation benchmarks	Annually
HOA/CSFS	Update CWPP	No more than 5 years

## 9. GLOSSARY

**acre:** an area of land containing 43,560 square feet. A square acre would be about 209 feet by 209 feet. A circular acre would have a radius of 117.75 feet.

**basal area:** the cross-sectional area of a single stem, including the bark, measured at breast height (4.5 feet above the ground) For example, the basal area of a tree 13.5 inches in diameter at breast height is about 1 square foot. Basal area = 0.005454 times diameter squared. (b) of an acre of forest: the sum of basal areas of the individual trees on the area. For example, a well stocked pine stand might contain 70 to 90 square feet of basal area per acre.

**canopy:** the foliage formed by the crowns of trees in a stand.

**defensible space:** an area around a structure where fuels and vegetation are treated, cleared or reduced to slow the spread of wildfire towards the structure.

**diameter at breast height (dbh):** the diameter of a stem of a tree at 4 ½ feet above the ground.

**downed fuels:** the accumulated woody and vegetative material on the forest floor from leaf/needle fall, natural pruning and breakage that serves as fuel for wildfire.

**ecosystem:** A spatially explicit, relatively homogenous unit of the earth that includes all interacting organisms (plants, animals, microbes) and components of the abiotic environment within its boundaries. An ecosystem can be of any size: a log, pond, field, forest, or the earth's biosphere.

**fuel loading:** the oven-dry weight of fuel per unit area.

**ladder fuels:** combustible material that provides vertical continuity between vegetation strata and allow fire to climb into the crowns of trees or shrubs with relative ease.

**litter:** the surface layer of a forest floor that is not in an advanced stage of decomposition, usually consisting of freshly fallen leaves, needles, twigs, stems, bark, and fruits.

**lop and scatter:** a hand method of removing the up-ward branches from tips of felled trees to keep slash low to the ground, to increase rate of decomposition, lower fire hazard, or as a pre-treatment prior to burning.

**sapling:** a usually young tree larger than a seedling but smaller than a pole.

**shaded fuelbreak:** A strategically located strip or block of land (of varying width) depending on fuel and terrain, in which fuel density is reduced, thus improving fire control opportunities. The stand is thinned and remaining trees are pruned to remove

ladder fuels. Most brush, heavy ground fuels, snags and dead trees are removed and an open park-like appearance established.

**silviculture:** the art, science, and practice of establishing, tending, and reproducing forest stands of desired characteristics. It is based on knowledge of species characteristics and environmental requirements.

**slash:** the residue of treetops and branches left on the ground after logging or accumulating as a result of storms, fire, girdling or delimiting.

**snag:** a standing, generally unmerchantable dead tree from which the leaves and most of the branches have fallen.

**stand:** a contiguous group of trees sufficiently uniform in age-class distribution, composition, and structure, and growing on a site of sufficiently uniform quality, to be a distinguishable unit.

**thinning:** a cultural treatment made to reduce stand density of trees primarily to improve growth, enhance forest health, or recover potential mortality.

**Wildland-Urban Interface:** The geographical meeting point of two diverse systems - wildland and structures. In the WUI, structures and vegetation are sufficiently close so that a wildland fire could spread to structures or a structure fire could ignite vegetation.

Definitions except defensible space, shaded fuelbreak and Wildland-Urban Interface from *The Dictionary of Forestry*, John A. Helms, editor.

## **10. LITERATURE CITED**

- Anderson, H.E. 1982.** Aids to Determining Fuel Models for Estimating Fire Behavior. USDA Forest Service General Technical Report INT-GTR-122. Intermountain Forest and Range Experiment Station. Ogden, UT. 22 p.
- Davis, J., Smith E. and Beck, G. 2007.** Cheatgrass and Wildfire. Colorado State University Cooperative Extension Resource Publication no. 6.310. 3 p.
- Dennis, F.C. 1999a.** Creating Wildfire-Defensible Zones. Colorado State University Cooperative Extension Resource Publication no. 6.302. 6 p.
- Dennis, F.C. 1999b** Fire-Resistant Landscaping. Colorado State University Cooperative Extension Resource Publication no. 6.303. 4 p.
- Dennis, F.C. 2002.** FireWise Plant Materials. Colorado State University Cooperative Extension Resource Publication no. 6.305. 6p.
- Dennis, F.C..** Fuel Break Guidelines for Forested Subdivisions & Communities. Colorado State Forest Service. 8 p.
- Helms, J.A., ed. 1998.** The Dictionary of Forestry. The Society of American Foresters. Bethesda, MD. 210 p.
- La Plata County Community Wildfire Protection Plan. 2006.** La Plata County, Colorado. 12 p.
- Scott, Joe H., Burgan, Robert E. 2005.** Standard fire behavior fuel models: a comprehensive set for use with Rothermel's surface fire spread model. Gen. Tech. Rep. RMRS-GTR-153. Fort Collins, CO; USDA Forest Service, Rocky Mountain Research Station. 72p.
- Slack, P. 1999.** Firewise Construction, Design and Materials. Colorado State Forest Service, Ft. Collins, CO. 38 p.



## **APPENDICES**

**A. Maps**

**B. Creating Wildfire-Defensible Zones (CSU Extension Pub. 6.302, F. C. Dennis)**

**C. Fuelbreak Guidelines for Forested Subdivisions (F.C. Dennis)**

**D. Fire-Resistant Landscaping (CSU Extension Pub. 6.303, F. C. Dennis)**

**E. FireWise Plant Materials (CSU Extension Pub. 6.305, F. C. Dennis)**

**F. Cheatgrass and Wildfire (CSU Extension Pub 6.310, Davison, Smith and Beck)**

**G. Firewise Construction, Design and Materials (P. Slack)**

## **Appendix A**

### **Maps**

- 1. Timberdale Ranch Vicinity**
- 2. Timberdale Ranch WUI**
- 3. Timberdale Ranch Vegetation Cover Types**
- 4. Timberdale Ranch Treatment Areas**

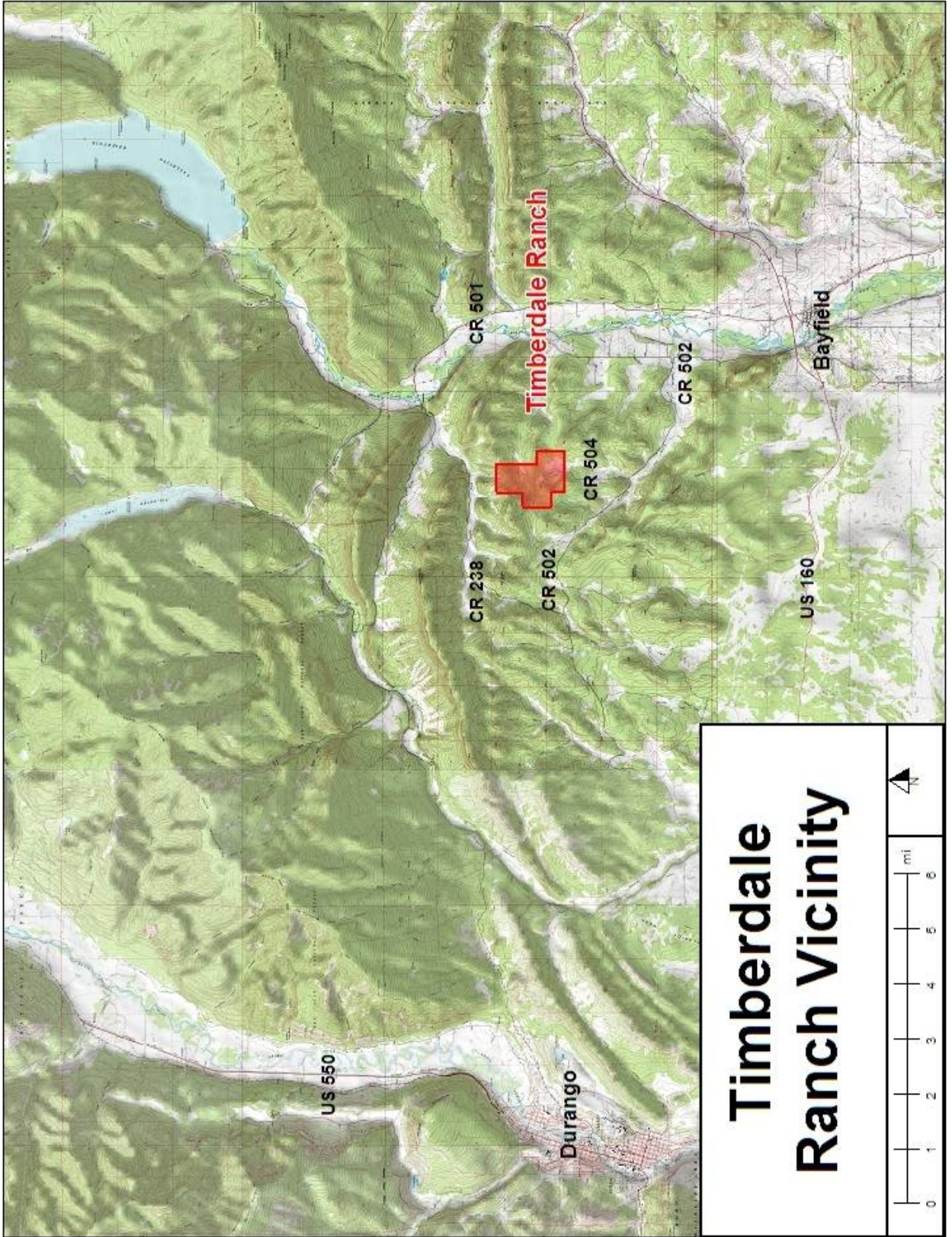

# Timberdale Ranch Vicinity

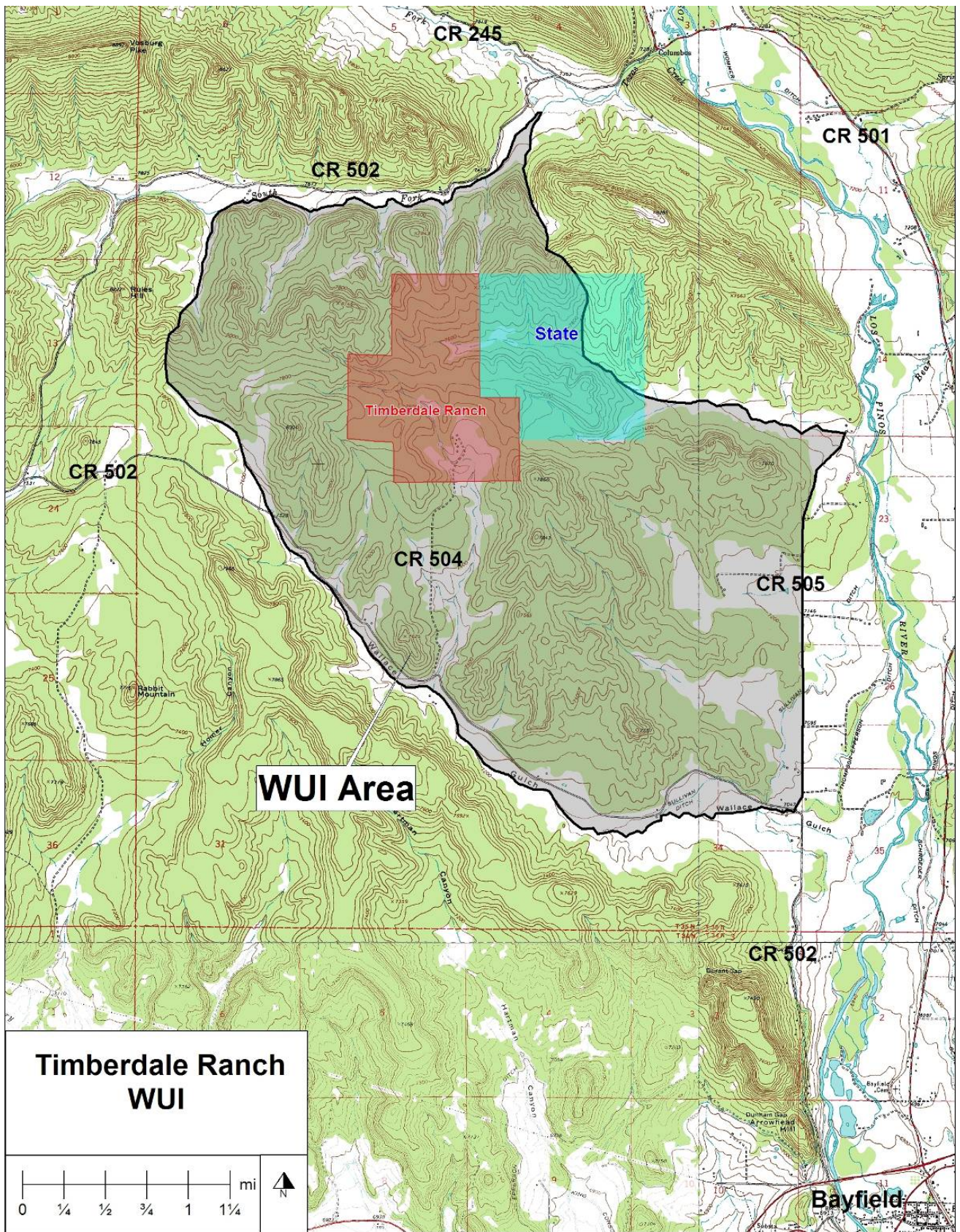

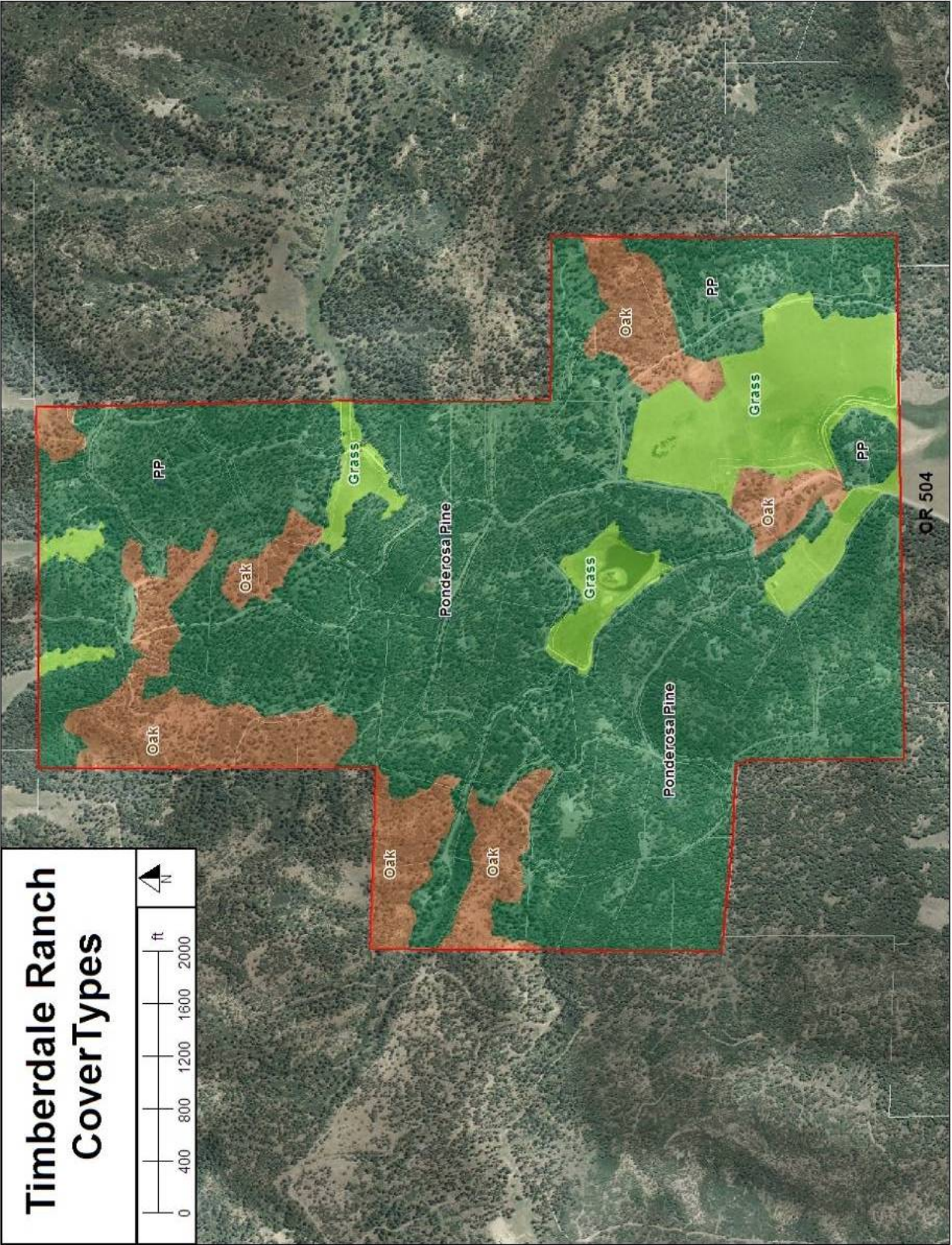

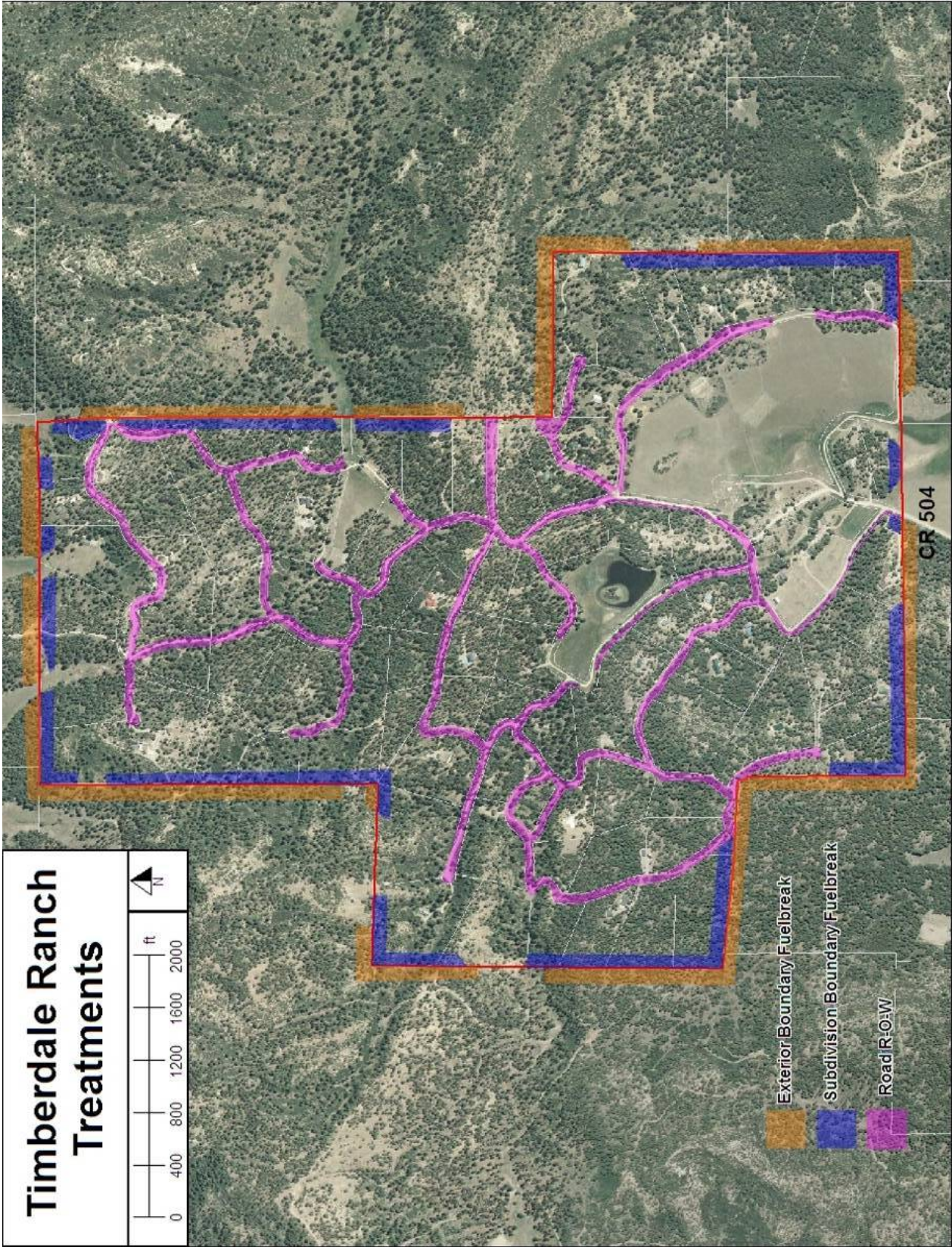

## **Appendix B**

### **Creating Wildfire-Defensible Zones**



# FORESTRY

## Creating Wildfire-Defensible Zones **no. 6.302**

by F.C. Dennis <sup>1</sup>

### Quick Facts...

Wildfire will find the weakest links in the defense measures you have taken on your property.

The primary determinants of a home's ability to survive wildfire are its roofing material and the quality of the "defensible space" surrounding it.

Even small steps to protect your home and property will make them more able to withstand fire.

Consider these measures for all areas of your property, not just the immediate vicinity of the house.

Fire is capricious. It can find the weak link in your home's fire protection scheme and gain the upper hand because of a small, overlooked or seemingly inconsequential factor. While you may not be able to accomplish all measures below (and there are no guarantees), each will increase your home's, and possibly your family's, safety and survival during a wildfire.

Start with the easiest and least expensive actions. Begin your work closest to your house and move outward. Keep working on the more difficult items until you have completed your entire project.

### Defensible Space

Two factors have emerged as the primary determinants of a home's ability to survive wildfire. These are the home's roofing material and the quality of the "defensible space" surrounding it.

Use fire-resistive materials (Class C or better rating), not wood or shake shingles, to roof homes in or near forests and grasslands. When your roof needs significant repairs or replacement, do so with a fire-resistant roofing material. Check with your county building department. Some counties now restrict wood roofs or require specific classifications of roofing material.

Defensible space is an area around a structure where fuels and vegetation are treated, cleared or reduced to slow the spread of wildfire towards the structure. It also reduces the chance of a structure fire moving from the building to the surrounding forest. Defensible space provides *room for firefighters to do their jobs*. Your house is more likely to withstand a wildfire if grasses, brush, trees and other common forest fuels are managed to reduce a fire's intensity.

The measure of fuel hazard refers to its continuity, both horizontal (across the ground) and vertical (from the ground up into the vegetation crown). Fuels with a high degree of both vertical and horizontal continuity are the most hazardous, particularly when they occur on slopes. Heavier fuels (brush and trees) are more hazardous (i.e. produce a more intense fire) than light fuels such as grass.

Mitigation of wildfire hazards focuses on breaking up the continuity of horizontal and vertical fuels. Additional distance between fuels is required on slopes.

Creating an effective defensible space involves developing a series of management zones in which different treatment techniques are used. See Figure 1 for a general view of the relationships among these management zones. Develop defensible space around each building on your property. Include detached garages, storage buildings, barns and other structures in your plan.

The actual design and development of your defensible space depends on several factors: size and shape of buildings, materials used in their construction, the slope of the ground on which the structures are built, surrounding topography,

**Colorado  
State**  
University  
Cooperative  
Extension

*Putting Knowledge to Work*

© Colorado State University  
Cooperative Extension. 5/03.  
Reviewed 1/06.  
www.ext.colostate.edu



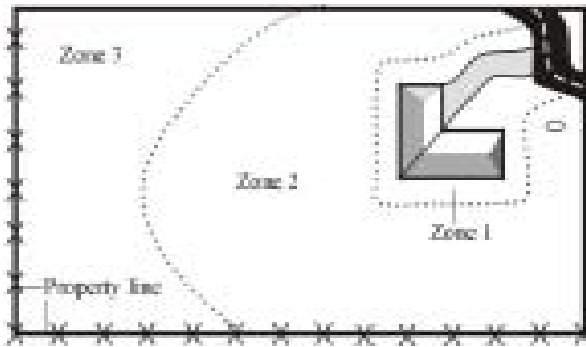

Figure 1: Forested property showing the three fire-defensible zones around a home or other structure.

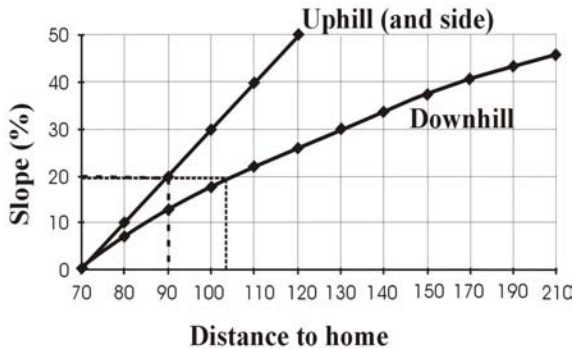

Figure 2: This chart indicates the minimum recommended dimensions for defensible space from the home to the outer edge of Zone 2. For example, if your home is situated on a 20 percent slope, the minimum defensible space dimensions would be 90 feet uphill and to the sides of the home and 104 feet downhill from the home.

and sizes and types of vegetation on your property. These factors all affect your design. You may want to request additional guidance from your local Colorado State Forest Service (CSFS) forester or fire department. (See the Special Recommendations section of this fact sheet for shrubs, lodgepole pine, Engelmann spruce, and aspen.)

## Defensible Space Management Zones

**Zone 1** is the area of maximum modification and treatment.

It consists of an area of 15 feet around the structure in which all flammable vegetation is removed. This 15 feet is measured from the outside edge of the home’s eaves and any attached structures, such as decks.

**Zone 2** is an area of fuel reduction. It is a transitional area between Zones 1 and 3. The size of Zone 2 depends on the slope of the ground where the structure is built. Typically, the defensible space should extend *at least* 75 to 125 feet from the structure. See Figure 2 for the appropriate distance for your home’s defensible space. Within this zone, the continuity and arrangement of vegetation is modified. Remove stressed, diseased, dead or dying trees and shrubs. Thin and prune the remaining larger trees and shrubs. Be sure to extend thinning along either side of your driveway all the way to your main access road. These actions help eliminate the continuous fuel surrounding a structure while enhancing homesite safety and the aesthetics of the property.

**Zone 3** is an area of traditional forest management and is of no particular size. It extends from the edge of your defensible space to your property boundaries.

## Prescriptions

### Zone 1

The size of Zone 1 is 15 feet, measured from the edges of the structure. Within this zone, several specific treatments are recommended.

Plant nothing within 3 to 5 feet of the structure, particularly if the building is sided with wood, logs or other flammable materials. Decorative rock, for example, creates an attractive, easily maintained, nonflammable ground cover.

If the house has noncombustible siding, widely spaced foundation plantings of low growing shrubs or other “fire wise” plants are acceptable. Do not plant directly beneath windows or next to foundation vents. Be sure there are no areas of continuous grass adjacent to plantings in this area.

Frequently prune and maintain plants in this zone to ensure vigorous growth and a low growth habit. Remove dead branches, stems and leaves.

Do not store firewood or other combustible materials in this area. Enclose or screen decks with metal screening. Extend the gravel coverage under the decks. Do not use areas under decks for storage.

Ideally, remove all trees from Zone 1 to reduce fire hazards. If you do keep a tree, consider it part of the structure and extend the distance of the entire defensible space accordingly. Isolate the tree from any other surrounding trees. Prune it to at least 10 feet above the ground. Remove any branches that interfere with the roof or are within 10 feet of the chimney. Remove all “ladder fuels” from beneath the tree. Ladder fuels are vegetation with vertical continuity that allows fire to burn from ground level up into the branches and crowns of trees. Ladder fuels are potentially very hazardous but are easy to mitigate. No ladder fuels can be allowed under tree canopies. In all other areas, prune all branches of shrubs or trees up to a height of 10 feet above ground (or 1/2 the height, whichever is the least).

## Zone 2

Zone 2 is an area of fuel reduction designed to reduce the intensity of any fire approaching your home. Follow these recommended management steps.

Thin trees and large shrubs so there is at least 10 feet between crowns. Crown separation is measured from the furthest branch of one tree to the nearest branch on the next tree (Figure 3). On steep slopes, allow more space between tree crowns. (See Figure 4 for *minimum recommended* spacing for trees on steep slopes.) Remove all ladder fuels from under these remaining trees. Carefully prune trees to a height of at least 10 feet.

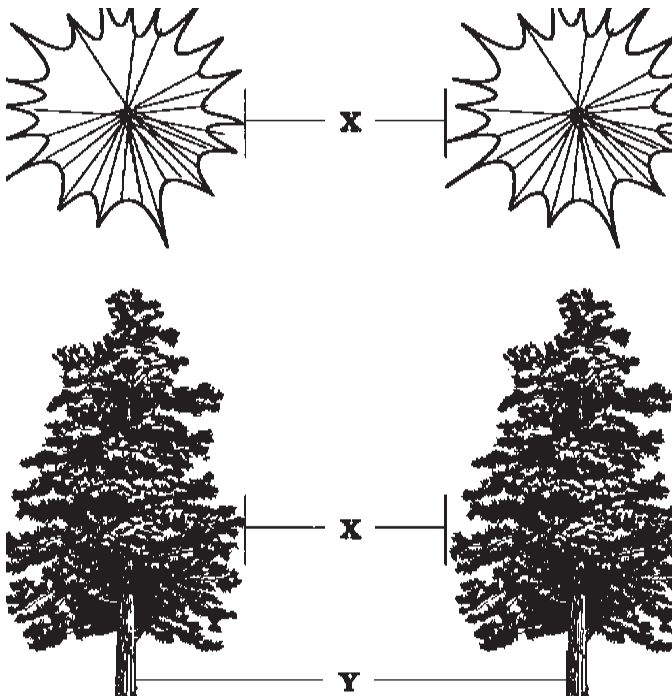

Figure 3: X = crown spacing; Y = stem spacing. Do not measure between stems for crown — measure between the edges of tree crowns.

Small clumps of 2 to 3 trees may be occasionally left in Zone 2. Leave more space between the crowns of these clumps and surrounding trees.

Because Zone 2 forms an aesthetic buffer and provides a transition between zones, it is necessary to blend the requirements for Zones 1 and 3. Thin the portions of Zone 3 adjacent to Zone 2 more heavily than the outer portions.

Isolated shrubs may remain, provided they are not under tree crowns. Prune and maintain these plants periodically to maintain vigorous growth. Remove dead stems from trees and shrubs annually. Where shrubs are the primary fuel in Zone 2, refer to the Special Recommendations section of this fact sheet.

Limit the number of dead trees (snags) retained in this area. Wildlife needs only one or two snags per acre. Be sure any snags left for wildlife cannot fall onto the house or block access roads or driveways.

Mow grasses (or remove them with a weed trimmer) as needed through the growing season to keep them low, a maximum of 6 to 8 inches. This is extremely critical in the fall when grasses dry out and cure or in the spring after the snow is gone but before the plants green up.

Stack firewood and woodpiles uphill or on the same elevation as the structure but at least 30 feet away. Clear and keep away flammable vegetation within 10 feet of these woodpiles. Do not stack wood against your house or on or under your deck, even in winter. Many homes have burned from a woodpile that ignited as the fire passed. Wildfires can burn at almost any time in Colorado.

Locate propane tanks at least 30 feet from any structures, preferably on the same elevation as the house. You don't want the LP container below your house — if it ignites, the fire would tend to burn uphill. On the other hand, if the tank is above your house and it develops a leak, LP gas will flow downhill into your home. Clear and keep away flammable vegetation within 10 feet of these tanks. Do not screen propane tanks with shrubs or vegetation.

Dispose of slash (limbs, branches and other woody debris) from your trees and shrubs through chipping or by piling and burning. Contact your local CSFS office or county sheriff's office for information about burning slash piles. If neither of these alternatives is possible, lop and scatter slash by cutting it into very small pieces and distributing it over the ground. Avoid heavy accumulations

% slope	Tree Crown Spacing	Brush and Shrub Clump Spacing
0 -10 %	10'	2 1/2 x shrub height
11 - 20%	15'	3 x shrub height
21 - 40%	20'	4 x shrub height
> 40%	30'	6 x shrub height

Figure 4: Minimum tree crown and shrub clump spacing.

Tree Diameter (in inches)	Average Stem Spacing Between Trees (in feet)
3	10
4	11
5	12
6	13
7	14
8	15
9	16
10	17
11	19
12	21
13	23
14	24
15	26
16	28
17	29
18	31
19	33
20	35
21	36
22	38
23	40
24	42

Figure 5: Minimum tree spacing for Zone 3.

of slash. Lay it close to the ground to speed decomposition. If desired, no more than two or three small, widely spaced brush piles may be left for wildlife purposes. Locate these towards the outer portions of your defensible space.

### Zone 3

This zone is of no specified size. It extends from the edge of your defensible space to your property lines. A gradual transition into this zone from defensible space standards to other management objectives you may have is suggested. Typical management objectives for areas surrounding homesites or subdivisions are: provide optimum recreational opportunities; enhance aesthetics; maintain tree health and vigor; provide barriers for wind, noise, dust and visual intrusions; support limited production of firewood, fence posts and other forest commodities; or grow Christmas trees or trees for transplanting.

Specific requirements will be dictated by your objectives for your land and the kinds of trees present. See Figure 5 for the *minimum* suggested spacing between “leave” trees. Forest management in Zone 3 is an opportunity for you to increase the health and growth rate of the forest in this zone. Keep in mind that root competition for available moisture limits tree growth and ultimately the health of the forest.

A high canopy forest reduces the chance of a surface fire climbing into the tops of the trees and might be a priority for you if this zone slopes steeply. The healthiest forest is one that has multiple ages, sizes, and species of trees where adequate growing room is maintained over time. Remember to consider the hazards of ladder fuels. Multiple sizes and ages of trees might increase the fire hazard from Zone 3 into Zone 2, particularly on steep slopes.

A greater number of wildlife trees can remain in Zone 3. Make sure that dead trees pose no threat to power lines or fire access roads.

While pruning generally is not necessary in Zone 3, it may be a good idea from the standpoint of personal safety to prune trees along trails and fire access roads. Or, if you prefer the aesthetics of a well-manicured forest, you might prune the entire area. In any case, pruning helps reduce ladder fuels within the tree stand, thus enhancing wildfire safety.

Mowing is not necessary in Zone 3.

Any approved method of slash treatment is acceptable for this zone, including piling and burning, chipping or lop-and-scatter.

## Special Recommendations

Tree spacing guidelines do not apply to *mature* stands of aspen trees where the recommendations for ladder fuels have been complied with. In areas of aspen regeneration and young trees, the spacing guidelines should be followed.

### Brush and shrubs

Brush and shrubs are woody plants, smaller than trees, often formed by a number of vertical or semi-upright branches arising close to the ground. Brush is smaller than shrubs and can be either woody or herbaceous vegetation.

On nearly level ground, minimum spacing recommendations between clumps of brush and/or shrubs is 2 1/2 times the height of the vegetation. Maximum diameter of clumps should be 2 times the height of the vegetation. As with tree crown spacing, all measurements are made from the edges of vegetation crowns (Figure 3).

For example: For shrubs 6 feet high, spacing between shrub clumps should be 15 feet or more apart (measured from the edges of the crowns of vegetation clumps). The diameter of shrub clumps should not exceed 12 feet (measured from the edges of the crowns). Branches should be pruned to a height of 3 feet.

## Grasses

Keep dead, dry or curing grasses mowed to less than 6 inches. Defensible space size where grass is the predominant fuel can be reduced (Figure 5) when applying this practice.

## Windthrow

In Colorado, certain locations and tree species, including lodgepole pine and Engelmann spruce, are especially susceptible to damage and uprooting by high winds (windthrow). If you see evidence of this problem in or near your forest, or have these tree species, consider the following adjustments to the defensible space guidelines. It is highly recommended that you contact a professional forester to help design your defensible space.

**Adjustments:** If your trees or homesite are susceptible to windthrow and the trees have never been thinned, use a stem spacing of diameter plus five instead of the guides listed in the Zone 3 section. Over time (every 3 to 5 years) *gradually* remove additional trees. The time between cutting cycles allows trees to “firm up” by expanding their root systems. Continue this periodic thinning until the desired spacing is reached.

Also consider leaving small clumps of trees and creating small openings on their lee side (opposite of the predominant wind direction). Again, a professional forester can help you design the best situation for your specific homesite and tree species. Remember, with species such as lodgepole pine and Engelmann spruce, the likelihood of a wildfire running through the tree tops or crowns (crowning) is closely related to the overabundance of fuels on the forest floor. Be sure to remove downed logs, branches and *excess* brush and needle buildup.

## Maintaining Your Defensible Space

Your home is located in a forest that is dynamic, always changing. Trees and shrubs continue to grow, plants die or are damaged, new plants begin to grow, and plants drop their leaves and needles. Like other parts of your home, defensible space requires maintenance. Use the following checklist each year to determine if additional work or maintenance is necessary.

% slope	D-space size (uphill, downhill, sidehill)
0 - 20 %	30'
21 - 40%	50'
> 40%	70'

Figure 6: Minimum defensible space size for grass fuels.

### Defensible Space and FireWise Annual Checklist

- Trees and shrubs are properly thinned and pruned within the defensible space. Slash from the thinning is disposed of.
- Roof and gutters are clear of debris.
- Branches overhanging the roof and chimney are removed.
- Chimney screens are in place and in good condition.
- Grass and weeds are mowed to a low height.
- An outdoor water supply is available, complete with a hose and nozzle that can reach all parts of the house.
- Fire extinguishers are checked and in working condition.
- The driveway is wide enough. The clearance of trees and branches is adequate for fire and emergency equipment. (Check with your local fire department.)
- Road signs and your name and house number are posted and easily visible.
- There is an easily accessible tool storage area with rakes, hoes, axes and shovels for use in case of fire.
- You have practiced family fire drills and your fire evacuation plan.
- Your escape routes, meeting points and other details are known and understood by all family members.
- Attic, roof, eaves and foundation vents are screened and in good condition.



FIREWISE is a multi-agency program that encourages the development of defensible space and the prevention of catastrophic wildfire.

Stilt foundations and decks are enclosed, screened or walled up.

- Trash and debris accumulations are removed from the defensible space.
- A checklist for fire safety needs inside the home also has been completed.

This is available from your local fire department.

## References

Colorado State Forest Service, Colorado State University, Fort Collins, CO 80523-5060; (970) 491-6303:

- *FireWise Construction — Design and Materials*
- Home Fire Protection in the Wildland Urban Interface
- Wildfire Protection in the Wildland Urban Interface
- *Landowner Guide to Thinning*

Colorado State University Cooperative Extension, 115 General Services Bldg., Fort Collins, CO 80523-4061; (970) 491-6198; E-mail: resourcecenter@ucm.colostate.edu:

- 6.303, *Fire-Resistant Landscaping*
- 6.304, *Forest Home Fire Safety*
- 6.305, *FireWise Plant Materials*
- 6.306, *Grass Seed Mixes to Reduce Wildfire Hazard*
- 7.205, *Pruning Evergreens*
- 7.206, *Pruning Shrubs*
- 7.207, *Pruning Deciduous Trees*

**Colorado  
State**  
FOREST  
SERVICE

This fact sheet was produced in cooperation with the Colorado State Forest Service.

<sup>1</sup>*Wildfire Hazard Mitigation Coordinator,  
Colorado State Forest Service.*

Colorado State University, U.S. Department of Agriculture, and Colorado counties cooperating. Cooperative Extension programs are available to all without discrimination. No endorsement of products mentioned is intended nor is criticism implied of products not mentioned.

## **Appendix C**

### **Fuelbreak Guidelines for Forested Subdivisions and Communities**



# Fuelbreak Guidelines for Forested Subdivisions & Communities

By

Frank C. Dennis



*Knowledge to Go Places*

This publication was developed for use by foresters, planners, developers, homeowners' associations and others. Implementation of these measures cannot *guarantee* safety from all wildfires, but will greatly increase the probability of containing them at more manageable levels.



*Inadequate fire planning can result in loss of life or property and costly suppression activities.*



Colorado's forested lands are experiencing severe impacts from continuing population increases and peoples' desire to escape urban pressures. Subdivisions and developments are opening new areas for homesite construction at an alarming rate, especially along the Front Range and around recreational areas such as Dillon, Vail, and Steamboat Springs.

But with development inevitably comes a higher risk of wildfire as well as an ever-increasing potential for loss of life and property. Methods of fire suppression, pre-suppression needs, and homeowner and fire crew safety must all be considered in the planning and review of new developments as well as for the "retrofitting" of existing, older subdivisions.

Fuelbreaks should be considered in fire management planning for subdivisions and developments; however, the following are guidelines **only**. They should be customized to local areas by professional foresters experienced in Rocky Mountain wildfire behavior and suppression tactics.

## Fuelbreak vs Firebreak

Although the term fuelbreak is widely used in Colorado, it is often confused with firebreak. The two are entirely separate, and aesthetically different, forms of forest fuel modification and treatment.

- A firebreak is strip of land, 20 to 30 feet wide (or more), in which all vegetation is removed down to bare, mineral soil each year prior to fire season.

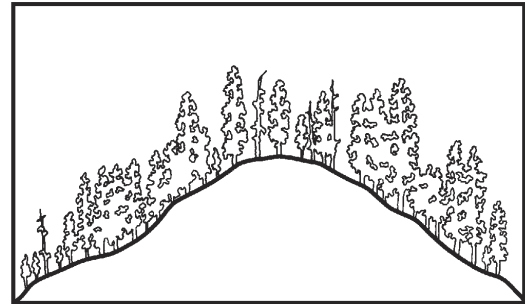

*Above, cross section of mixed conifer stand before fuelbreak modification. Below, after modification.*

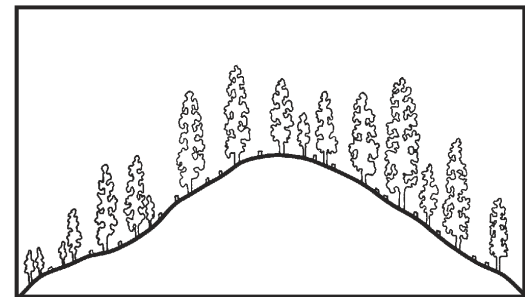

- A fuelbreak (or shaded fuelbreak) is an easily accessible strip of land of varying width (depending on fuel and terrain), in which fuel density is reduced, thus improving fire control opportunities. The stand is thinned, and remaining trees are pruned to remove ladder fuels. Brush, heavy ground fuels, snags, and dead trees are disposed of and an open, park-like appearance is established.

The following is a discussion of the uses, limitations, and specifications of fuelbreaks in wildfire control and fuels management.

## Fuelbreak Limitations

Fuelbreaks provide quick access for wildfire suppression. Control activities can be conducted more safely due to low fuel volumes. Strategically located, they break up large, continuous tracts of dense timber, thus limiting uncontrolled spread of wildfire.

Fuelbreaks can aid firefighters greatly by slowing fire spread under normal burning conditions. However, under extreme conditions, even the best fuelbreaks stand little chance of arresting a large





Before and after photos of a forest stand thinned to reduce fuel loads.

fire, regardless of firefighting efforts. Such fires, in a phenomenon called “spotting,” can drop firebrands 1/8-mile or more ahead of the main fire, causing very rapid fire spread. These types of large fires may continue until there is a major change in weather conditions, topography, or fuel type.

**It is critical to understand: A fuelbreak is the line of defense. The area (including any homes and developments) between it and the fire may remain vulnerable.**

In spite of these somewhat gloomy limitations, fuelbreaks have proven themselves effective in Colorado. During the 1980 Crystal Lakes Subdivision Fire near Fort Collins, crown fires were stopped in areas with fuelbreak thinnings, while other areas of dense lodgepole pine burned completely. A fire at O’Fallon Park in Jefferson County was successfully stopped and controlled at a fuelbreak. The Buffalo Creek Fire in Jefferson County (1996) and the High Meadow Fire in Park and Jefferson Counties (2000) slowed dramatically wherever intense forest thinnings had been completed. During the 2002 Hayman Fire, Denver Water’s entire complex of offices, shops and caretakers’ homes at Cheesman Reservoir were saved by a fuelbreak with no firefighting intervention by a fuelbreak.



Burned area near Cheesman Reservoir as a result of the Hayman Fire. Note the unburned green trees in the middle right of the photo, a treated fuelbreak.

### The Need For A Fuelbreak

Several factors determine the need for fuelbreaks in forested subdivisions, including: (1) potential problem indicators; (2) wildfire hazard areas; (3) slope; (4) topography; (5) crowning potential; and (6) ignition sources.

### Potential Problem Indicator

The table below explains potential problem indicators for various hazards and characteristics common to Colorado’s forest types. All major forest types, except aspen, indicate a high potential for wildfire hazard.

Fuel Type	Characteristics			Hazards			
	Aesthetics	Wildlife	Soil	Wildfire	Avalanche	Flood	Climate
Aspen	2	3	3	2	4	3	2
Douglas-fir	2	2	3	5	2	2	3
Greasewood-Saltbrush	4	2	2	2	1	3	3
Limber-Bristlecone Pine	3	2	4	3	4	2	5
Lodgepole Pine	2	2	3	5	4	2	4
Meadow	5	4	4	2	3	4	3
Mixed Conifer	2	1	1	5	3	1	3
Mountain Grassland	5	3	4	3	3	2	4
Mountain Shrub	3	5	4	4	2	2	3
Piñon-Juniper	2	3	4	4	2	3	2
Ponderosa Pine	2	3	1	5	2	2	3
Sagebrush	4	4	3	3	3	2	3
Spruce-Fir	2	3	3	4	5	3	4

Legend: 5 – Problem may be crucial; 4 – Problem very likely; 3 – Exercise caution; 2 – Problem usually limited; 1 – No rating possible

## Wildfire Hazard Maps

The Colorado State Forest Service (CSFS), numerous counties and some National Forests have completed wildfire hazard mapping for many areas within Colorado, particularly along the Front Range. These maps typically consider areas with 30 percent or greater slope; hazardous fuel types; and hazardous topographic features such as fire chimneys. Wildfire Hazard Ratings may be depicted in several ways. Whatever system is used, areas rated moderate or higher should be considered for fuel modification work.

### Slope

Rate of fire spread increases as the slope of the land increases. Fuels are preheated by the rising smoke column or they may even come into contact with the flames themselves.

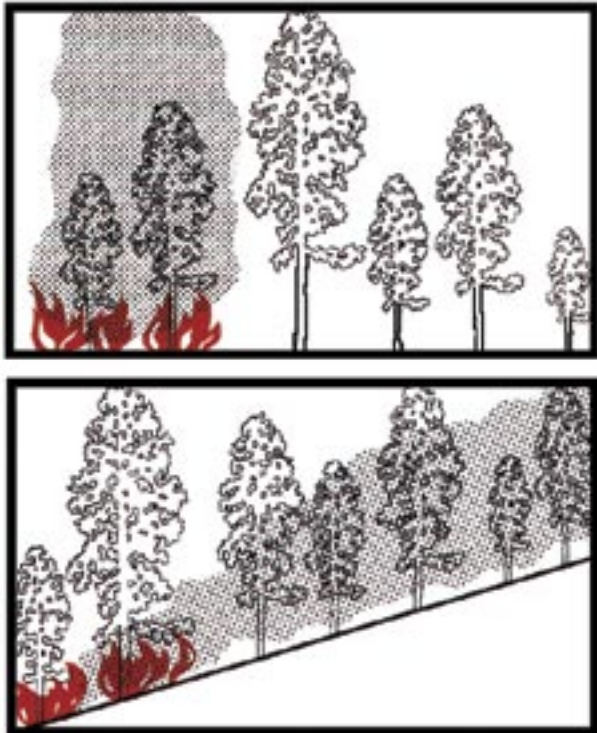

*Fire effects, flat vs steep terrain. Note preheating of fuels on steep ground from passage of smoke column.*

At 30 percent slope, rate of fire spread doubles compared to rates at level ground, drastically reducing firefighting effectiveness. **Areas near 30 percent or greater slopes are critical and must be reviewed carefully.**

### Topography

Certain topographic features influence fire spread and should be evaluated. Included are fire chimneys, saddles, and V-shaped canyons. They are usually recognized by reviewing standard U.S.G.S. quad maps.

- Chimneys are densely vegetated drainages on slopes greater than 30 percent. Wind, as well as air pre-heated by a fire, tends to funnel up these drainages, rapidly spreading fire upslope.

- Saddles are low points along a main ridge or between two high points. Like chimneys, they also funnel winds to create a natural fire path during a fire's uphill run. Saddles act as corridors to spread fire into adjacent valleys or drainages.



*Chimney.*



*Saddle.*

- Narrow, V-shaped valleys or canyons can ignite easily due to heat radiating from one side to the other. For example, a fire burning on one side of a narrow valley dries and preheats fuels on the opposite side until the fire "flashes over." The natural effect of slope on fire then takes over and fire spreads rapidly up drainage and uphill along both sides of the valley.



*Flashover in V-shaped valley.*

## Crowning Potential

An on-site visit is required to accurately assess crowning potential. A key, below, helps determine this rating. Fuel modification is usually unnecessary if an area has a rating of 3 or less.

### Crowning Potential Key

	Rating
A. Foliage present, trees living or dead — B	
B. Foliage living — C	
C. Leaves deciduous or, if evergreen, usually soft, pliant, and moist; never oily, waxy, or resinous.	0
CC. Leaves evergreen, not as above — D	
D. Foliage resinous, waxy, or oily — E	
E. Foliage dense — F	
F. Ladder fuels plentiful — G	
G. Crown closure > 75 percent	9
GG. Crown closure < 75 percent	7
FF. Ladder fuels sparse or absent — H	
H. Crown closure > 75 percent	7
HH. Crown closure < 75 percent	5
EE. Foliage open — I	
I. Ladder fuel plentiful	4
II. Ladder fuel sparse or absent	2
DD. Foliage not resinous, waxy, or oily — J	
J. Foliage dense — K	
K. Ladder fuels plentiful — L	
L. Crown closure > 75 percent	7
LL. Crown closure < 75 percent	4
KK. Ladder fuels sparse or absent — M	
M. Crown closure > 75 percent	5
MM. Crown closure < 75 percent	3
JJ. Foliage open — N	
N. Ladder fuels plentiful	3
NN. Ladder fuels sparse or absent	1
BB. Foliage dead	0

The majority of dead trees within the fuelbreak should be removed. Occasionally, large, dead trees (14 inches or larger in diameter at 4 1/2 feet above ground level) may be retained as wildlife trees. If retained, all ladder fuels must be cleared from around the tree's trunk.

### Ignition Sources

Possible ignition sources, which may threaten planned or existing developments, must be investigated thoroughly. Included are other developments and homes, major roads, recreation sites, railroads, and other possible sources. These might be distant from the proposed development,

yet still able to channel fire into the area due to slope, continuous fuels, or other topographic features.

### Fuelbreak Locations

In fire suppression, an effective fire line is connected, or "anchored," to natural or artificial fire barriers. Such anchor points might be rivers, creeks, large rock outcrops, wet meadows, or a less flammable timber type such as aspen. Similarly, properly designed and constructed fuelbreaks take advantage of these same barriers to eliminate "fuel bridges." (Fire often escapes control because of fuel bridges that carry the fire across control lines.)

Since fuelbreaks should normally provide quick, safer access to defensive positions, they are necessarily linked with road systems. Connected with county-specified roads within subdivisions, they provide good access and defensive positions for firefighting equipment and support vehicles. Cut-and fill slopes of roads are an integral part of a fuelbreak as they add to the effective width of modified fuels.

Fuelbreaks without an associated road system, such as those located along strategic ridge lines, are still useful in fire suppression. Here, they are often strengthened and held using aerial retardant drops until fire crews can walk in or be ferried in by helicopter.

Preferably, fuelbreaks are located along ridge tops to help arrest fires at the end of their runs. However, due to homesite locations and resource values, they can also be effective when established at the base of slopes. Mid-slope fuelbreaks are least desirable, but under certain circumstances and with modifications, these too, may be valuable.

Fuelbreaks are located so that the area under management is broken into small, manageable units. Thus, when a wildfire reaches modified fuels, defensive action is more easily taken, helping to keep the fire small. For example, a plan for a subdivision might recommend that fuelbreaks break up continuous forest fuels into units of 10 acres or less. This is an excellent plan, especially if defensible space thinning is completed around homes and structures, and thinning for forest management and forest health are combined with the fuelbreak.

When located along ridge tops, continuous length as well as width are critical elements. Extensive long-range planning is essential in positioning these types of fuelbreaks.

## Aesthetics

Improperly planned fuelbreaks can adversely impact an area's aesthetic qualities. Careful construction is necessary when combining mid-slope fuelbreaks with roads involving excessive cut-and-fill.



*These photos, far- and near- views of the same site, illustrate that forest can be thinned without impacting aesthetics.*

Care must also be taken in areas that are not thinned throughout for fuel hazard reduction. In such cases the fuelbreak visually sticks out like a "sore thumb" due to contrasting thinned and unthinned portions of the forest. (Especially noticeable are those portions of the fuelbreak above road cuts).

These guidelines are designed to minimize aesthetic impacts. However, some situations may require extensive thinning and, thus, result in a major visual change to an area. Additional thinning beyond the fuelbreak may be necessary to create an irregular edge and to "feather," or blend, the fuelbreak thinning into the unthinned portions of the forest. Any thinning beyond the fuelbreak improves its effectiveness and is highly recommended.

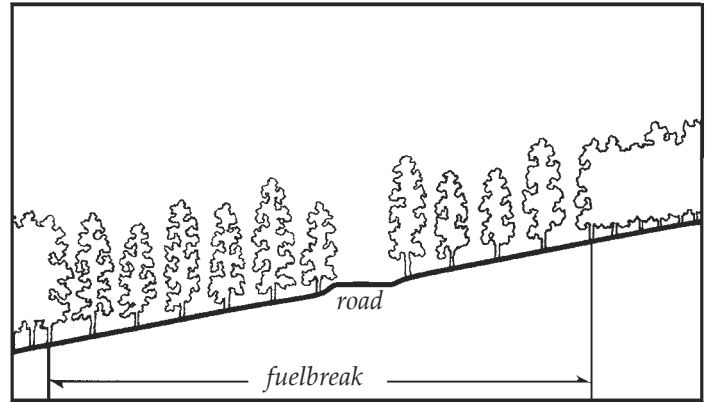

*Cross-section of a typical fuelbreak built in conjunction with a road.*

## Constructing the Fuelbreak

### Fuelbreak Width and Slope Adjustments

Note: Since road systems are so important to fuelbreak construction, the following measurements are from the toe of the fill for downslope distances, and above the edge of the cut for uphill distances.

The minimum recommended fuelbreak width is approximately 300 feet for level ground. Since fire activity intensifies as slope increases, the overall fuelbreak width must also increase. However, to minimize aesthetic impacts and to maximize fire crew safety, the majority of the increases should be made at the bottom of the fuelbreak, below the road cut.

Widths are also increased when severe topographic conditions are encountered. Guidelines for fuelbreak widths on slopes are given below:

Fuelbreak Width/Slope			
Percent Slope (%)	Minimum Uphill Distance (ft)	Minimum Downhill Distance (ft)	Total Width of Modified fuels (ft)*
0	150	150	300
10	140	165	303
20	130	180	310
30	120	195	315
40	110	210	320
50	100	225	325
60	100	240	340

\*As slope increases, total distance for cut-and-fill for road construction rapidly increases, improving fuelbreak effective width.

## Stand Densities

Crown separation is a more critical factor for fuelbreaks than a fixed tree density level. A *minimum* 10-foot spacing between the edges of tree crowns is recommended on level ground. As slope increases, crown spacing should also increase. However, small, isolated groups of trees may be retained for visual diversity. Increase crown spacing around any groups of trees left for aesthetic reasons and to reduce fire intensities and torching potential.

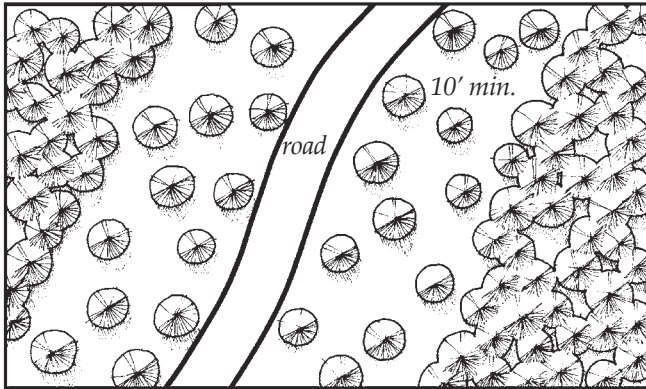

Plan view of fuelbreak showing minimum distance between tree crowns.

In technical terms, a fuelbreak thinning is classified as a heavy “sanitation and improvement cut, from below.” Within fuelbreaks, trees that are suppressed, diseased, deformed, damaged, or of low vigor are removed along with all ladder fuels. Remaining trees are the largest, healthiest, most wind-firm trees from the dominant and co-dominant species of the stand.

Because such a thinning is quite heavy for an initial entry into a stand, prevailing winds, eddy effects, and wind funneling must be carefully evaluated to minimize the possibility of windthrow. It may be necessary to develop the fuelbreak over several years to allow the timber stand to “firm-up” — this especially applies to lodgepole pine and Engelmann spruce stands.

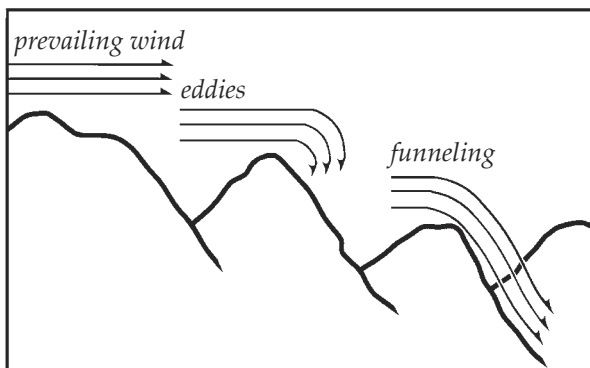

Topography affects wind behavior – an important consideration during fuelbreak construction.

Area-wide forest thinnings are recommended for any subdivisions. Such thinning is not as severe as a fuelbreak thinning, but generally should be completed to fuelbreak specifications along the roads (as outlined on page 6.) In addition, “defensible space thinnings” are highly recommended around all structures (see CSU Coop. Extension Fact sheet 6.302, *Creating Wildfire-Defensible Zones*).

## Debris Removal

Limbs and branches left from thinning (slash) can add significant volumes of fuel to the forest floor, especially in lodgepole pine, mixed-conifer, or spruce/fir timber types. These materials can accumulate and serve as ladder fuels, or can become “jackpots,” increasing the difficulty of defending the fuelbreak during a wildfire. **Slash decomposes very slowly in Colorado and proper disposal is essential.** Proper treatment reduces fire hazard, improves access for humans and livestock, encourages establishment of grasses and other vegetation, and improves aesthetics.

Three treatment methods are commonly used. These are lopping-and-scattering, piling and burning, and chipping. Mulching of small trees and slash using equipment similar to Hydro-axes or Timbcos equipped with mulching heads are becoming a popular method of treatment. Size, amount, and location of slash dictates the method used, in addition to cost and the final desired appearance. The method chosen will also depend on how soon an effective fuelbreak is needed prior to construction in new developments.



Lop and scatter: slash should be no deeper than 12” above ground surface.



*Chipping is the most desirable, but also the most expensive method of slash disposal.*



*Piled slash can be burned but only during certain conditions, such as after a snowfall.*

## Fuelbreak Maintenance

Following initial thinning, trees continue to grow (usually at a faster rate). The increased light on the forest floor encourages heavy grass and brush growth where, in many cases, where little grew before. The site disturbance and exposed mineral soil created during fuelbreak development is a perfect seed bed for new trees that, in turn, create new ladder fuels. Thus, in the absence of maintenance, fuelbreak effectiveness will decrease over time.



*Fuelbreak maintenance is essential. Ingrowth, shown above, will minimize the effectiveness of this fuelbreak within a few years.*

Fuelbreak maintenance problems are most often the result of time and neglect. Misplaced records, lack of follow-up and funding, and apathy caused by a lack of fire events are some of the major obstacles. In addition, the responsibility for fuelbreak maintenance projects is often unclear. For example, control of a fuelbreak completed by a developer passes to a homeowner's association, usually with limited funds and authority to maintain fuelbreaks.

**If fuelbreak maintenance is not planned and completed as scheduled, consider carefully whether the fuelbreak should be constructed. An un-maintained fuelbreak may lead to a false sense of security among residents and fire suppression personnel.**

## Conclusion

An image of well-designed communities for Colorado includes:

- Forested subdivisions where the total forest cover is well-managed through carefully planned, designed, and maintained thinnings. This contributes to reduced wildfire hazards and a much healthier forest — one that is more resistant to insects and disease.
- A system of roads and driveways with their associated fuelbreaks that break up the continuity of the forest cover and fuels. These help keep fires small, while also providing safer locations from which to mount fire suppression activities. In addition to allowing fire personnel in, they will allow residents to evacuate if necessary.
- Individual homes that all have defensible space around them, making them much easier to defend and protect from wildfire, while also protecting the surrounding forest from structure fires.

Creation of such communities is entirely feasible if recognition of the fire risks, a spirit of cooperation, an attitude of shared responsibility, and the political will exists.

*Colorado's mountains comprise diverse slopes, fuel types, aspects, and topographic features. This variety makes it impossible to develop general fuelbreak prescriptions for all locations. **The previous recommendations are guidelines only.** A professional forester with fire suppression expertise should be consulted to "customize" fuelbreaks for particular areas.*

## **Appendix D**

### **Fire-Resistant Landscaping**



# FORESTRY

---

## Fire-Resistant Landscaping

no. 6.303

by F.C. Dennis<sup>1</sup>

### Quick Facts...

More people are moving into Colorado's rural areas, increasing the chances of wildfire.

"Defensible space" is the primary determinant of a structure's ability to survive wildfire.

Native species are generally the best plant materials for landscaping in defensible space, but others can be grown successfully in Colorado.

To be a FireWise homeowner, plan well, plant well and maintain well.

Colorado's population is growing, its urban areas are rapidly expanding, and people are building more homes in what was once natural forest and brushlands. Newcomers to rural areas need to know how to correctly landscape their property to reduce wildfire hazards.

Improper landscaping worries land managers and fire officials because it can greatly increase the risk of structure and property damage from wildfire. It is a question of *when*, not *if*, a wildfire will strike any particular area.

Vegetative clearance around the house (defensible space) is a primary determinant of a home's ability to survive wildfire. Defensible space is, simply, room for firefighters to do their job. If grasses, brush, trees and other common forest fuels are removed, reduced, or modified to lessen a fire's intensity and keep it away from the home, chances increase that the structure will survive. It is a little-known fact that in the absence of a defensible space, firefighters will often bypass a house, choosing to make their stand at a home where their safety is more assured and the chance to successfully protect the structure is greater.

### Landscaping Defensible Space

People often resist creating defensible space because they believe that it will be unattractive, unnatural and sterile-looking. It doesn't have to be! Wise landowners carefully plan landscaping within the defensible space. This effort yields a many-fold return of beauty, enjoyment and added property value. Development of defensible space is outlined in fact sheet 6.302, *Creating Wildfire-Defensible Zones*.

Colorado has great diversity in climate, geology and vegetation. Home and cabin sites can be found from the foothills through 10,000-foot elevations. Such extremes present a challenge in recommending plants. While native plant materials generally are best, a wide range of species can be grown successfully in Colorado.

Many plant species are suitable for landscaping in defensible space. Use restraint and common sense, and pay attention to plant arrangement and maintenance. It has often been said that *how* and *where* you plant are more important than *what* you plant. While this is indeed true, given a choice among plants, choose those that are more resistant to wildfire.

Consider the following factors when planning, designing and planting the FireWise landscape within your home's defensible space:

- Landscape according to the recommended defensible-space zones. That is, the plants near your home should be more widely spaced and lower growing than those farther away.
- Do not plant in large masses. Instead, plant in small, irregular clusters or islands.

**Colorado**  
**State**  
University

**Extension**



The best tree species to plant generally are those naturally occurring on or near the site.

Mow grass short around shrubs.

Plant low-growing, nonresinous shrubs near structures.

Keep grass mown around structures to a maximum of 8 inches.

Plant wildflowers near structures only if they are well-irrigated and cut back during the dormant season.

Gravel area or mow grass short next to the structure.

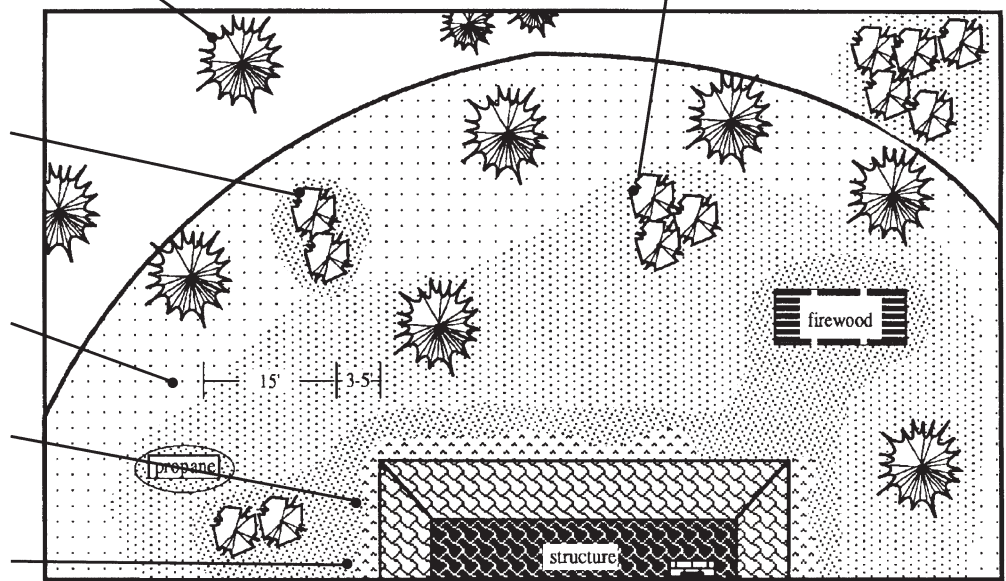

Figure 1: Forested property surrounding a homesite; shows optimum placement of vegetation near the structure.

- Use decorative rock, gravel and stepping stone pathways to break up the continuity of the vegetation and fuels. This can modify fire behavior and slow the spread of fire across your property.
- Incorporate a diversity of plant types and species in your landscape. Not only will this be visually satisfying, but it should help keep pests and diseases from causing problems within the whole landscape.
- In the event of drought and water rationing, prioritize plants to be saved. Provide available supplemental water to plants closest to your house.
- Use mulches to conserve moisture and reduce weed growth. Mulch can be organic or inorganic. Do not use pine bark, thick layers of pine needles or other mulches that readily carry fire.
- Be creative! Further vary your landscape by including bulbs, garden art and containers for added color.

## References

- 6.302, *Creating Wild-Fire Defensible Zones*
- 6.304, *Forest Home Fire Safety*
- 6.305, *FireWise Plant Materials*
- 6.306, *Grass Seed Mixes to Reduce Wildfire Hazard*
- 7.233, *Wildflowers for Colorado*
- 7.406, *Flowers for Mountain Communities*
- 7.413, *Ground Covers for Mountain Communities*
- 7.423, *Trees and Shrubs for Mountain Areas*

## Grasses

During much of the year, grasses ignite easily and burn rapidly. Tall grass will quickly carry fire to your house. Mow grasses low in the inner zones of the defensible space. Keep them short closest to the house and gradually increase height outward from the house, to a maximum of 8 inches. This is particularly important during fall, winter and before green-up in early spring, when grasses are dry, dormant and in a “cured” fuel condition. Given Colorado’s extremely variable weather, wildfires can occur any time of the year. Maintenance of the grassy areas around your home is critical.

Mow grasses low around the garage, outbuildings, decks, firewood piles, propane tanks, shrubs, and specimen trees with low-growing branches.

## Ground Cover Plants

Replace bare, weedy or unsightly patches near your home with ground covers, rock gardens, vegetable gardens and mulches. Ground cover plants are a good alternative to grass for parts of your defensible space. They break up the monotony of grass and enhance the beauty of your landscape. They provide a



Figure 2: Ladder fuels enable fire to travel from the ground surface into shrubs and then into the tree canopy.

variety of textures and color and help reduce soil erosion. Consider ground cover plants for areas where access for mowing or other maintenance is difficult, on steep slopes and on hot, dry exposures.

Ground cover plants are usually low growing. They are succulent or have other FireWise characteristics that make them useful, functional and attractive. When planted in beds surrounded by

walkways and paths, in raised beds or as part of a rock garden, they become an effective barrier to fire spread. The ideal groundcover plant is one which will spread, forming a dense mat of roots and foliage that reduces soil erosion and excludes weeds.

Mulch helps control erosion, conserve moisture and reduce weed growth. It can be organic (compost, leaf mold, bark chips, shredded leaves) or it can be inorganic (gravel, rock, decomposing granite).

When using organic mulches, use just enough to reduce weed and grass growth. Avoid thick layers. When exposed to fire, they tend to smolder and are difficult to extinguish. Likewise, while your property might yield an abundance of needles from your native pines or other conifers, don't use them as mulch because they can readily catch and spread wildfire. Rake, gather and dispose of them often within your defensible space.

## Wildflowers

Wildflowers bring variety to a landscape and provide color from May until frost. Wildflower beds give a softer, more natural appearance to the otherwise manicured look often resulting from defensible space development.

A concern with wildflowers is the tall, dense areas of available fuel they can form, especially in dormancy. To reduce fire hazard, plant wildflowers in widely separated beds within the defensible space. Do not plant them next to structures unless the beds are frequently watered and weeded and vegetation is promptly removed after the first hard frost. Use gravel walkways, rock retaining walls or irrigated grass areas mowed to a low height to isolate wildflower beds from each other and from other fuels.

## Shrubs

Shrubs lend color and variety to the landscape and provide cover and food for wildlife. However, shrubs concern fire professionals because, as the next level in the "fuel continuum," they can add significantly to total fuel loading. Because of the woody material in their stems and branches, they are a potential source of fire brands. When carried in the smoke column ahead of the main fire, fire brands can rapidly spread the fire in a phenomenon known as "spotting."

But the primary concern with shrubs is that they are a "ladder fuel" – they can carry a relatively easy-to-control surface grass fire into tree crowns. Crown fires are difficult, sometimes impossible, to control (see Figure 2).

To reduce the fire-spreading potential of shrubs, plant only widely separated, low-growing, nonresinous varieties close to structures. Do not plant them directly beneath windows or vents or where they might spread under wooden decks. Do not plant shrubs under tree crowns or use them to screen propane tanks, firewood piles or other flammable materials. Plant shrubs individually, as specimens, or in small clumps apart from each other and away from any trees within the defensible space.

Mow grasses low around shrubs. Prune dead stems from shrubs annually. Remove the lower branches and suckers from species such as Gambel oak to raise the canopy away from possible surface fires.

### **Structural Elements of a FireWise Landscape**

*When building a deck or patio, use concrete, flagstone or rock instead of wood. These materials do not burn and do not collect flammable debris like the space between planks in wooden decking.*

*Where appropriate on steeper ground, use retaining walls to reduce the steepness of the slope. This, in turn, reduces the rate of fire spread. Retaining walls also act as physical barriers to fire spread and help deflect heat from the fire upwards and away from structures.*

*Rock or masonry walls are best, but even wooden tie walls constructed of heavy timbers will work. Put out any fires burning on tie walls after the main fire front passes.*

*On steep slopes, consider building steps and walkways around structures. This makes access easier for home maintenance and enjoyment. It also serves as a physical barrier to fire spread and increases firefighters' speed and safety as they work to defend your home.*



FIREWISE is a multi-agency program that encourages the development of defensible space and the prevention of catastrophic wildfire.



This fact sheet was produced in cooperation with the Colorado State Forest Service.

<sup>1</sup>Wildfire Hazard Mitigation Coordinator, Colorado State Forest Service.

## Trees

Trees provide a large amount of available fuel for a fire and can be a significant source of fire brands if they do burn. Radiant heat from burning trees can ignite nearby shrubs, trees and structures.

Colorado's elevation and temperature extremes limit tree selection. The best species to plant generally are those already growing on or near the site. Others may be planted with careful selection and common sense.

If your site receives enough moisture to grow them, plant deciduous trees such as aspen or narrow-leaf cottonwood. These species, even when planted in dense clumps, generally do not burn well, if at all. The greatest problem with these trees is the accumulation of dead leaves in the fall. Remove accumulations close to structures as soon as possible after leaf drop.

When site or available moisture limits recommended species to evergreens, carefully plan their placement. Do not plant trees near structures. Leave plenty of room between trees to allow for their growth. Spacing within the defensible space should be at least 10 feet between the edges of tree crowns. On steep ground, allow even more space between crowns. Plant smaller trees initially on a 20- to 25-foot spacing to allow for tree growth. At some point, you will have to thin your trees to retain proper spacing.

As the trees grow, prune branches to a height of 10 feet above the ground. Do not overprune the crowns. A good rule of thumb is to remove no more than one-third of the live crown of the tree when pruning. Prune existing trees as well as ones you planted.

Some trees (for example, Colorado blue spruce) tend to keep a full crown. Other trees grown in the open may also exhibit a full growth habit. Limit the number of trees of this type within the defensible space. Prune others as described above and mow grasses around such specimen trees.

## Maintenance

A landscape is a dynamic system that constantly grows and changes. Plants considered fire resistant and that have low fuel volumes can lose these characteristics over time. Your landscape, and the plants in it, must be maintained to retain their FireWise properties.

- Always keep a watchful eye towards reducing the fuel volumes available to fire. Be aware of the growth habits of the plants within your landscape and of the changes that occur throughout the seasons.
- Remove annuals and perennials after they have gone to seed or when the stems become overly dry.
- Rake up leaves and other litter as it builds up through the season.
- Mow or trim grasses to a low height within your defensible space. This is particularly important as grasses cure.
- Remove plant parts damaged by snow, wind, frost or other agents.
- Timely pruning is critical. Pruning not only reduces fuel volumes but also maintains healthier plants by producing more vigorous, succulent growth.
- Landscape maintenance is a critical part of your home's defense system. Even the best defensible space can be compromised through lack of maintenance. The old adage "An ounce of prevention is worth a pound of cure" applies here.

Colorado State University, U.S. Department of Agriculture, and Colorado counties cooperating. Extension programs are available to all without discrimination. No endorsement of products mentioned is intended nor is criticism implied of products not mentioned.

## **Appendix E**

### **Firewise Plant Materials**



# FORESTRY

---

## FireWise Plant Materials

no. 6.305

by F.C. Dennis<sup>1</sup> (1/08)

### Quick Facts...

FireWise landscaping can be aesthetically pleasing while reducing potential wildfire fuel.

Plant choice, spacing and maintenance are critical.

Your landscape, and the plants in it, must be maintained to retain their FireWise properties.

Creating a “defensible space” around your home is one of the most important and effective steps you can take to protect you, your family and your home from catastrophic wildfire. Defensible space is the area between a structure and an oncoming wildfire where nearby vegetation has been modified to reduce a wildfire’s intensity. (See fact sheet 6.302, *Creating Wildfire-Defensible Zones*.)

Many people resist creating defensible space around their homes because they believe these areas will be unattractive and unnatural. This is far from true. With careful planning, FireWise landscaping can be aesthetically pleasing while reducing potential wildfire fuel. It can actually enhance beauty and property values, as well as personal safety.

Many native plants are highly flammable during different seasons of the year. At such times, left unmanaged, they can accelerate the spread of a wildfire through your neighborhood, threatening homes, property and lives.

All vegetation, naturally occurring and otherwise, is potential fuel for fire. Its type, amount and arrangement has a dramatic effect on fire behavior. There are no truly “fireproof” plant species, so plant choice, spacing and maintenance are critical to defensible space landscaping. In fact, **where** and **how** you plant may be more important than **what** you plant. However, given alternatives, choose plant species that tend to be more resistant to wildfire.

General concepts to keep in mind when choosing and planting FireWise species are:

- A plant’s moisture content is the single most important factor governing its volatility. (However, *resin* content and other factors in some species render them flammable even when the plant is well-watered.) Conifers tend to be flammable due to their oil and pitch content, regardless of their water content.
- Deciduous plants tend to be more fire resistant because their leaves have higher moisture content and their basic chemistry is less flammable. Also, when deciduous trees are dormant, there is less fuel to carry fire through their canopies.

In some cases, there is a strong correlation between drought tolerance and fire resistance. For example, a plant may shed its leaves or needles during extreme drought. Other drought-tolerant species may have smaller leaves or thick, succulent leaves. These plants offer less fuel or have a higher moisture content, both of which help reduce fire hazard.

There also appears to be a correlation between a plant’s salt tolerance and natural fire resistance. Plants adapted to salty conditions, and actually growing in salty situations, may better resist burning.

Colorado  
State  
University

Extension

# FireWise Plant List

The following list was prepared by Phil Hoefer, Colorado State Forest Service. It was reviewed by Jim Knopf, a landscape architect in Boulder, and two landscape architects on Colorado's Western Slope. Bloom time is approximate (observed in Boulder at 5,600 feet).

Key: Water needs: VL = very low L = low M = medium H = high  
 Sun/Shade: S = sun PS = part sun Sh = shade  
 Elevation: Y = Yes N = No ? = Questionable or unknown

Scientific Name	Common Name	Approx.	Sun/Shade	Approx.	Elevation					Approx.
		Water Needs	Preference	Mature Height	(1,000 ft.)	5	6	7	8	9
<b>Flowers and Ground Covers</b>										
<i>Achillea lanulosa</i> <sup>a</sup>	Native yarrow	L-H	S/PS	1.5 - 2'	Y	Y	Y	Y	Y	Jul
<i>Achillea tomentosa</i> <sup>b</sup>	Woolly yarrow	M-H	S/PS	.5'	Y	Y	N	N	N	Jul
<i>Aconitum</i> spp. <sup>c</sup>	Monkshood	M-H	S	2'	Y	Y	Y	Y	Y	Jun-Jul
<i>Aconitum columbianum</i> <sup>ac</sup>	Columbian monkshood	M-H	S	2'	Y	Y	Y	Y	Y	Jun-Jul
<i>Ajuga reptans</i> <sup>b</sup>	Bugleweed	H	Sh	< .5'	Y	Y	Y	Y	Y	Jun-Jul
<i>Alchemilla</i> sp.	Lady's mantle	M-H	PS/Sh	1'	Y	Y	Y	Y	?	Jun-Jul
<i>Allium cernuum</i> <sup>ac</sup>	Nodding onion	L-H	S/PS	1'	Y	Y	Y	Y	Y	Jun
<i>Allium geyeri</i> <sup>ac</sup>	Geyer onion	L-H	S/PS	1'	Y	Y	Y	Y	?	Jun
<i>Anaphalis margaritacea</i> <sup>a</sup>	Pearly everlasting	L-H	S	1.5 - 2.5'	Y	Y	Y	Y	?	Aug
<i>Anemone blanda</i>	Windflower	M-H	S/PS	1'	Y	Y	Y	Y	?	Apr-May
<i>Antennaria parvifolia</i> <sup>ab</sup>	Small-leaf pussytoes	M	S/PS	<.5'	Y	Y	Y	Y	Y	Jun
<i>Antennaria rosea</i> <sup>ab</sup>	Rosy pussytoes	M	S/PS	<.5'	Y	Y	Y	Y	Y	Jun
<i>Aquilegia</i> spp.	Columbine	M-H	S/PS	1 - 2'	Y	Y	Y	Y	Y	Jun-Jul
<i>Aquilegia coerulea</i> <sup>a</sup>	Colorado blue columbine	M-H	S/PS	1 - 2'	Y	Y	Y	Y	Y	Jun-Jul
<i>Aquilegia chrysantha</i> <sup>a</sup>	Yellow columbine	M-H	S/PS	1 - 2'	Y	Y	Y	Y	Y	Jun-Aug
<i>Arabis</i> sp. <sup>b</sup>	Rockcress	L-H	S	< 1'	Y	Y	Y	Y	Y	May-Jun
<i>Armeria maritima</i>	Sea thrift	L-H	S/PS	.5'	Y	Y	Y	Y	Y	Apr-Jun
<i>Artemisia caucasica</i>	Caucasian sage	L-M	S/PS	1 - 2'	Y	Y	Y	?	?	n/a
<i>Artemisia frigida</i> <sup>ac</sup>	Fringed sage	L-M	S	1 - 1.5'	Y	Y	Y	Y	Y	n/a
<i>Artemisia ludoviciana</i> <sup>a</sup>	Prairie sage	L-M	S	1 - 1.5'	Y	Y	Y	?	?	n/a
<i>Aster laevis</i> <sup>a</sup>	Smooth aster	L-H	S/PS	1 - 3'	Y	Y	Y	Y	?	Aug-Sep
<i>Aster porteri</i> <sup>a</sup>	Porter aster	L-M	S	1'	Y	Y	Y	?	?	Aug-Sep
<i>Aubrieta</i> sp. <sup>b</sup>	False rockcress	M	S	1'	Y	Y	Y	Y	Y	Apr-May
<i>Aurinia</i> sp. <sup>b</sup>	Basket of gold	M	S/PS	1'	Y	Y	Y	Y	Y	Apr-May
<i>Calochortus gunnisonii</i> <sup>a</sup>	Mariposa lily	M-H	S	.5 - 2'	Y	Y	Y	Y	?	Jul-Aug
<i>Campanula rotundifolia</i> <sup>a</sup>	Common harebell	M-H	S	.5 - 1'	Y	Y	Y	Y	Y	May-Oct
<i>Centranthus ruber</i>	Jupiter's beard	L-H	S/Sh	2 - 2.5'	Y	Y	Y	Y	?	May-Oct
<i>Cerastium strictum</i> <sup>ab</sup>	Mouse ear chickweed	M	S/PS	1'	Y	Y	Y	Y	?	May-Jun
<i>Cerastium tomentosum</i> <sup>b</sup>	Snow-in-summer	L-M	S/PS	1'	Y	Y	Y	Y	Y	May-Jun
<i>Claytonia lanceolata</i> <sup>a</sup>	Spring beauty	M	Sh	.5 - 1.5'	Y	Y	Y	?	?	Mar-Apr
<i>Convallaria majalis</i> <sup>bc</sup>	Lily-of-the-valley	H	Sh	< 1'	Y	Y	Y	Y	?	May-Jun
<i>Delosperma nubigenum</i> <sup>b</sup>	Hardy yellow iceplant	M-H	S	.5'	Y	Y	Y	?	?	Jun
<i>Delphinium</i> spp. <sup>c</sup>	Delphinium	M-H	S/PS	.5 - 3'+	Y	Y	Y	Y	Y	Jun-Jul
<i>Dianthus</i> spp.	Pinks	L-H	S	<.5' - 2'	Y	Y	Y	Y	Y	May-Aug
<i>Doronicum</i> sp.	Leopard's bane	H	S/PS	2 - 3'	Y	Y	Y	Y	?	Jul-Aug
<i>Echinacea purpurea</i> <sup>a</sup>	Purple coneflower	M	S	2 - 3'	Y	Y	Y	Y	Y	Jul-Aug
<i>Epilobium angustifolium</i>	Fireweed	H	S/PS	3'	N	Y	Y	Y	Y	Jul-Aug
<i>Erigeron flagellaris</i> <sup>a</sup>	Whiplash daisy, trailing fleabane	L-M	S	< 1'	Y	Y	?	?	?	Jun-Jul
<i>Eriogonum umbellatum</i> <sup>a</sup>	Sulphur flower	M	S/PS	<.5'	Y	Y	Y	Y	Y	Jun-Jul
<i>Erysimum asperum</i> <sup>a</sup>	Western wallflower	M	S/PS	1'+	Y	Y	Y	Y	?	Jun-Jul
<i>Gaillardia aristata</i> <sup>a</sup>	Blanket flower	L-M	S	1 - 1.5'	Y	Y	Y	Y	Y	Jul-Sep
<i>Galium boreale</i> <sup>ab</sup>	Northern bedstraw	M-H	Sh	<1'	Y	Y	Y	Y	Y	May-Jun
<i>Geranium</i> spp.	Hardy geraniums	M	Sh/PS	2'	Y	Y	Y	Y	Y	May-Oct
<i>Geranium caespitosum</i> <sup>a</sup>	Wild geranium	M	Sh/PS	2'	Y	Y	Y	Y	Y	May-Oct
<i>Geum triflorum</i>	Prairie smoke	M-H	S/PS	1.5'	Y	Y	Y	?	?	Jun
<i>Helianthella quinquenervis</i> <sup>a</sup>	Aspen sunflower	M	S	1'	?	?	?	Y	Y	?
<i>Helianthemum nummularium</i>	Rockrose	M-H	S	< 1'	Y	Y	Y	?	?	May-Jun
<i>Helianthus pumilus</i> <sup>a</sup>	Small sunflower	M	S	1 - 2'	Y	Y	Y	?	?	Jun-Jul
<i>Heuchera</i> spp.	Coral bells	M-H	PS/Sh	1 - 2'	Y	Y	Y	Y	Y	Jun-Aug
<i>Ipomopsis aggregata</i> <sup>a</sup>	Scarlet gilia	M	S/PS	1 - 2'	Y	Y	Y	Y	Y	Jun-Aug
<i>Iris germanica</i>	Bearded iris	L-M	S	1 - 3'	Y	Y	Y	Y	Y	May-Jun

Scientific Name	Common Name	Approx. Water Needs	Sun/Shade Preference	Approx. Mature Height	Elevation (1,000 ft.)					Approx. Bloom Month
					5	6	7	8	9	
<i>Iris missouriensis</i> <sup>ac</sup>	Missouri iris	M-H	S	1 - 2'	Y	Y	Y	Y	Y	May
<i>Lamium</i> sp. <sup>b</sup>	Dead nettle	M-H	Sh	< 1'	Y	Y	Y	Y	?	May-Jun
<i>Lavandula</i> spp.	Lavender	L-M	S	1 - 2'	Y	Y	Y	?	?	Jun-Nov
<i>Leucocrinum montanum</i> <sup>a</sup>	Sand lily	L-M	S	< 1'	Y	Y	Y	?	?	May
<i>Liatris punctata</i> <sup>a</sup>	Dotted gayfeather	VL-L	S	1 - 2'	Y	Y	Y	Y	Y	Aug-Oct
<i>Linum lewisii</i> <sup>ac</sup>	Wild blue flax	L-H	S/PS	1 - 2'	Y	Y	Y	Y	Y	May-Sep
<i>Lupinus argenteus</i> <sup>ac</sup>	Silver lupine	M	Sh/PS	1 - 3'	Y	Y	Y	Y	Y	Jun-Jul
<i>Mertensia lanceolata</i> <sup>a</sup>	Narrow-leaved chiming bells	M-H	Sh/PS	1 - 2'	Y	Y	Y	Y	Y	May-Jun
<i>Mimulus guttatus</i> <sup>a</sup>	Yellow monkey-flower	H	Sh	1'	?	Y	Y	Y	Y	?
<i>Monarda fistulosa</i> <sup>a</sup>	Native beebalm	M-H	S/PS	1 - 2'	Y	Y	Y	Y	Y	Jul-Oct
<i>Oenothera caespitosa</i> <sup>a</sup>	White stemless evening primrose	L-M	S	1 - 2'	Y	Y	Y	Y	Y	Jun-Aug
<i>Papaver orientale</i>	Oriental poppy	H	S/Sh	2 - 3'	Y	Y	Y	Y	Y	May-Jun
<i>Penstemon caespitosus</i> <sup>ab</sup>	Mat penstemon	L-M	S	< .5'	Y	Y	Y	Y	Y	Jun
<i>Penstemon secundiflorus</i>	Sidebells	L-M	S	1 - 2'	Y	Y	Y	Y	?	May-Jun
<i>Penstemon teucrioides</i> <sup>a</sup>	Germander penstemon	L-M	S	.5'	Y	Y	Y	?	?	Jun-Jul
<i>Penstemon virens</i> <sup>ac</sup>	Blue mist penstemon	M	S/PS	.5'	Y	Y	Y	Y	Y	May-Jun
<i>Phlox subulata</i>	Moss phlox	M	S	< .5'	Y	Y	Y	Y	Y	May
<i>Polemonium</i> sp.	Jacob's ladder	H	S/PS	1 - 2'	Y	Y	Y	Y	Y	May-Aug
<i>Potentilla fissa</i> <sup>a</sup>	Leafy potentilla	M-H	PS	1'	Y	Y	Y	Y	?	?
<i>Potentilla verna</i> <sup>b</sup>	Spring potentilla	M-H	PS	< .5'	Y	Y	Y	Y	Y	Mar-May
<i>Pulsatilla patens</i> <sup>a</sup>	Pasque flower	M	S/PS	1'	Y	Y	Y	Y	Y	Mar-May
<i>Ratibida columnifera</i> <sup>a</sup>	Prairie coneflower	L-M	S	2'	Y	Y	Y	Y	Y	Jul-Sep
<i>Rudbeckia hirta</i> <sup>a</sup>	Black-eyed Susan	M-H	S	2 - 3'	Y	Y	Y	Y	Y	Jul-Sep
<i>Salvia officinalis</i>	Cooking sage	L-M	S/PS	2'	Y	Y	Y	Y	?	Jun
<i>Saxifraga hirsuta</i>	Saxifrage	H	S/PS	.5'+	Y	Y	Y	Y	Y	May-Jun
<i>Scutellaria brittonii</i> <sup>a</sup>	Skullcap	M	S/PS	.5 - 1'	Y	Y	Y	Y	?	Aug-Sep
<i>Sedum</i> spp. <sup>b</sup>	Stonecrop	M	S/PS	1 - 1.5'	Y	Y	Y	Y	Y	Jul-Aug
<i>Sedum lanceolatum</i> <sup>a</sup>	Yellow stonecrop	M	S/PS	.5'	Y	Y	Y	Y	Y	Jul-Aug
<i>Sempervivum</i> sp.	Hens and chicks	L-M	S/PS	.5'	Y	Y	Y	Y	Y	n/a
<i>Senecio spartioides</i> <sup>ac</sup>	Broom groundsel	VL-L	S	2 - 3'	Y	Y	?	?	?	Sep-Oct
<i>Solidago missouriensis</i> <sup>a</sup>	Smooth goldenrod	L-M	S	1 - 2'	Y	Y	Y	Y	?	Jul-Aug
<i>Thalictrum fendleri</i> <sup>a</sup>	Fendler meadowrue	H	S/PS	2 - 3'	?	?	Y	Y	Y	Jul-Aug
<i>Thermopsis divaricarpa</i> <sup>a</sup>	Spreading golden banner	M-H	S/PS	2'	Y	Y	Y	Y	?	May
<i>Tradescantia occidentalis</i> <sup>a</sup>	Western spiderwort	M	S/PS	1.5'	Y	Y	Y	Y	?	Jun-Aug
<i>Thymus</i> spp. <sup>b</sup>	Thyme	L-M	S	< .5'	Y	Y	Y	Y	Y	Jun-Jul
<i>Veronica pectinata</i>	Speedwell	L-M	S	< .5'	Y	Y	Y	Y	Y	Apr-Jul
<i>Vinca minor</i> <sup>b</sup>	Periwinkle, myrtle	H	Sh	< 1'	Y	Y	Y	Y	?	Apr-Jun
<i>Waldsteinia</i> sp. <sup>b</sup>	Barren strawberry	M-H	Sh/PS	< 1'	Y	Y	Y	Y	?	May-Jun

**Shrubs**

<i>Arctostaphylos nevadensis</i> <sup>ab</sup>	Pinemat manzanita	M	S/PS	1 - 2'	Y	Y	Y	N	N	n/a
<i>Arctostaphylos patula</i> <sup>a</sup>	Greenleaf manzanita	M	S/PS	3 - 4'	Y	Y	Y	N	N	n/a
<i>Arctostaphylos uva-ursi</i> <sup>ab</sup>	Kinnikinnick, bearberry	M	S/Sh	1'	Y	Y	Y	Y	Y	n/a
<i>Betula glandulosa</i> <sup>a</sup>	Bog birch	H	S/PS	6 - 8'	Y	Y	Y	Y	Y	n/a
<i>Calluna</i> sp.	Heather	H	S/PS	2'	Y	Y	Y	?	?	Jul-Aug
<i>Ceanothus fendleri</i> <sup>a</sup>	Buckbrush, mountain lilac	M	S	2'	Y	Y	Y	?	?	Jul
<i>Cercocarpus intricatus</i> <sup>a</sup>	Little-leaf mountain mahogany	VL-L	S	4 - 6'	Y	Y	Y	Y	?	n/a
<i>Cercocarpus montanus</i> <sup>ac</sup>	True mountain mahogany	L-M	S	4 - 6'	Y	Y	Y	Y	?	n/a
<i>Chrysothamnus</i> spp. <sup>a</sup>	Rabbitbrush	VL-L	S	2 - 6'	Y	Y	Y	Y	Y	Jul-Aug
<i>Cornus stolonifera</i> <sup>a</sup>	Redtwig dogwood	H	S/Sh	4 - 6'	Y	Y	Y	Y	Y	n/a
<i>Cotoneaster horizontalis</i>	Spreading cotoneaster	M	S/PS	2 - 3'	Y	Y	Y	Y	?	May-Jun
<i>Daphne burkwoodii</i>	Burkwood daphne	M	S/PS	2 - 3'	Y	Y	Y	?	?	Apr-Jun
<i>Erica</i> sp.	Heath	H	S/PS	1'	Y	Y	Y	?	?	Jan-Mar
<i>Euonymus alatus</i>	Burning bush euonymus	M	S/Sh	1 - 6'	Y	Y	Y	?	?	n/a
<i>Fallugia paradoxa</i> <sup>a</sup>	Apache plume	VL-L	S	2 - 4'	Y	Y	Y	Y	Y	Jun-Oct
<i>Holodiscus dumosus</i> <sup>a</sup>	Ocean spray, cliff/rock spirea	L-M	S/PS	4'	Y	Y	Y	Y	Y	Jun
<i>Jamesia americana</i> <sup>a</sup>	Wax flower	M-H	S/Sh	2 - 6'	Y	Y	Y	Y	Y	Jun
<i>Lonicera tatarica</i>	Tatarian honeysuckle	M	S/PS	4 - 6'	Y	Y	Y	Y	Y	May-Jun
<i>Mahonia aquifolium</i>	Oregon grape holly	M-H	S/Sh	4 - 6'	Y	Y	Y	?	?	May-Jun

Scientific Name	Common Name	Approx. Water Needs	Sun/Shade Preference	Approx. Mature Height	Elevation (1,000 ft.)					Approx. Bloom Month
					5	6	7	8	9	
<i>Mahonia repens</i> <sup>ab</sup>	Creeping grape holly	L-H	S/Sh	1 - 2'	Y	Y	Y	Y	Y	Mar-May
<i>Philadelphus microphyllus</i> <sup>a</sup>	Little-leaf mockorange	M	S	2 - 3'	Y	Y	Y	Y	?	Jun
<i>Physocarpus monogynus</i> <sup>a</sup>	Mountain ninebark	M	S/Sh	2 - 4'	Y	Y	Y	Y	Y	Jun
<i>Potentilla fruticosa</i> <sup>a</sup>	Shrubby cinquefoil	M	S/PS	2 - 3'	Y	Y	Y	Y	Y	May-Sep
<i>Prunus besseyi</i> <sup>a</sup>	Western sand cherry	L-M	S	1 - 3'	Y	Y	Y	Y	?	May
<i>Purshia tridentata</i> <sup>a</sup>	Antelope bitterbrush	L-M	S	1 - 2'	Y	Y	Y	?	?	Jun-Aug
<i>Ribes aureum</i> <sup>a</sup>	Golden currant	M	S/PS	2 - 3'	Y	Y	Y	Y	Y	Apr-May
<i>Rosa woodsii</i> <sup>a</sup>	Woods' or native wild rose	M	S/PS	2 - 3'	Y	Y	Y	Y	Y	Jun-Jul
<i>Shepherdia canadensis</i> <sup>d</sup>	Russet buffaloberry	M-H	S	5 - 6'	Y	Y	Y	Y	Y	n/a
<i>Symphoricarpos</i> spp. <sup>d</sup>	Snowberry, coralberry	M	S/PS	2 - 3'	Y	Y	Y	Y	Y	n/a
<i>Viburnum edule</i> <sup>a</sup>	Highbush cranberry	H	S	6 - 8'	Y	Y	Y	Y	Y	May-Jun
<i>Yucca baccata</i> <sup>a</sup>	Banana or broad-leaf yucca	VL-L	S/PS	2 - 3'	Y	Y	Y	N	N	Jun
<i>Yucca filamentosa</i>	Adam's needle	M	S/PS	2 - 3'	Y	Y	Y	N	N	Jun
<i>Yucca glauca</i> <sup>a</sup>	Spanish bayonet, small soapweed, Great Plains yucca	VL-L	S/PS	2 - 3'	Y	Y	Y	Y	?	Jun

#### Large Shrubs and Trees

<i>Acer ginnala</i>	Ginnala maple	M-H	S	6 - 10'	Y	Y	Y	Y	Y	n/a
<i>Acer glabrum</i> <sup>a</sup>	Rocky Mountain maple	M-H	S/Sh	6 - 10'	Y	Y	Y	Y	Y	n/a
<i>Acer grandidentatum</i> <sup>a</sup>	Wasatch maple	M	S/PS	10 - 20'	Y	Y	Y	Y	?	n/a
<i>Alnus tenuifolia</i> <sup>a</sup>	Thinleaf alder	H	S/PS	6 - 8'	Y	Y	Y	Y	Y	Apr
<i>Amelanchier alnifolia</i> <sup>ac</sup>	Saskatoon alder-leaf serviceberry	M	S/PS	6 - 8'	Y	Y	Y	Y	Y	Apr-May
<i>Amelanchier utahensis</i> <sup>a</sup>	Utah serviceberry	VL-M	S	4 - 6'	Y	Y	N	N	N	May
<i>Betula fontinalis</i> <sup>a</sup>	River birch	H	S/PS	6 - 8'	Y	Y	Y	Y	?	n/a
<i>Cercocarpus ledifolius</i> <sup>a</sup>	Mountain mahogany	VL-L	S	6 - 15'	Y	Y	?	N	N	n/a
<i>Corylus cornuta</i> <sup>a</sup>	Filbert, beaked hazelnut	H	S/Sh	5 - 6'	Y	Y	Y	?	?	n/a
<i>Crataegus</i> spp. <sup>a</sup>	Hawthorn (several native)	M	S	6 - 8'	Y	Y	Y	Y	?	May
<i>Fraxinus pennsylvanica</i>	Green ash	M-H	S	20 - 25'	Y	Y	Y	Y	?	n/a
<i>Gleditsia triacanthos</i>	Honeylocust	M-H	S	60 - 70'	Y	Y	N	N	N	May
<i>Malus</i> sp.	Crabapple	M	S	10 - 15'	Y	Y	Y	Y	N	Apr-May
<i>Physocarpus opulifolius</i> <sup>a</sup>	Tall ninebark	M	S/PS	4 - 6'	Y	Y	Y	?	N	May
<i>Populus tremuloides</i> <sup>a</sup>	Aspen	M	S	8 - 25'	Y	Y	Y	Y	Y	n/a
<i>Prunus americana</i> <sup>a</sup>	American wild plum	M	S/PS	4 - 6'	Y	Y	Y	Y	N	Apr
<i>Prunus cerasifera</i> <sup>c</sup>	Flowering plum	M	S/PS	8 - 10'	Y	Y	Y	?	N	Apr
<i>Prunus pennsylvanica</i> <sup>ac</sup>	Pin/fire/wild/red cherry	M	S/PS	6 - 8'	Y	Y	Y	?	N	May
<i>Prunus virginiana melanocarpa</i> <sup>ac</sup>	Western chokecherry	M-H	S/PS	6 - 8'	Y	Y	Y	Y	Y	Apr-May
<i>Rubus deliciosus</i> <sup>a</sup>	Boulder raspberry, thimbleberry	M	S/Sh	4 - 6'	Y	Y	Y	Y	Y	Apr-May
<i>Salix amygdaloides</i> <sup>a</sup>	Peachleaf willow	H	S/PS	20 - 30'	Y	Y	Y	Y	?	n/a
<i>Shepherdia argentea</i> <sup>a</sup>	Silver buffaloberry	M	S/PS	4 - 6'	Y	Y	Y	Y	?	Apr
<i>Sorbus scopulina</i> <sup>a</sup>	Western mountain ash	M-H	S/Sh	6 - 8'	Y	Y	Y	Y	?	May
<i>Syringa vulgaris</i>	Common lilac	M	S	6 - 8'	Y	Y	Y	Y	Y	May

<sup>a</sup> Native species.

<sup>b</sup> Ground cover plant.

<sup>c</sup> This species, or some species in this genus, may be poisonous to livestock, pets, wildlife and/or people under some conditions. Before planting, check with Colorado State University Cooperative Extension, Colorado State Forest Service, or other knowledgeable personnel.

<sup>d</sup> Several species of *symphoricarpos* are native.



## Plants for a FireWise Landscape

Plants that are more resistant to wildfire have one or more of the following characteristics:

- They grow without accumulating large amounts of combustible dead branches, needles or leaves (example: aspen).
- They have open, loose branches with a low volume of total vegetation (examples: currant and mountain mahogany).
- They have low sap or resin content (examples: many deciduous species).
- They have high moisture content (examples: succulents and some herbaceous species).
- They grow slowly and need little maintenance (do not need frequent pruning).
- They are short and grow close to the ground (examples: wildflowers and groundcovers).
- They can resprout following fire, thus reducing relandscaping costs (example: aspen).



### Conifers

*In Colorado, conifers make up much of our natural forest. Because of their high resin content, they are more susceptible to fire.*

*Even though conifers are flammable, you do not need to remove all of them from around your home. Wildfire hazards usually can be effectively reduced through proper thinning and pruning of existing trees and shrubs.*

*When choosing conifers for your defensible space, consider those with characteristics that make them better able to survive fire:*

- thick bark,
- long needles, or
- self-pruning. (Self-pruning trees lose lower branches naturally, leaving a greater distance between ground and canopy.)

## Additional FireWise Guidelines

Some additional tips to follow when planning a FireWise landscape include:

- Landscape according to the recommended defensible-space zones. The plants nearest your home should be more widely spaced and smaller than those farther away.
- Plant in small, irregular clusters and islands, not in large masses.
- Break up the continuity of the vegetation (fuel) with decorative rock, gravel and stepping stone pathways. This will help modify fire behavior and slow its spread across your property.
- Plant a variety of types and species. Besides being aesthetically pleasing, this will help ensure a healthier forest by reducing insects and diseases. Healthy, vigorous, thinned forests can better resist catastrophic fires than unhealthy ones with insect and disease problems.
- In the event of drought and water rationing, prioritize the plants you wish to save. Provide supplemental water to those nearest your home, perhaps using “gray water.”
  - Mulch to conserve moisture and reduce weed growth. Mulch can be organic (wood chips or small bark pieces) or inorganic (gravel or rock). Avoid pine bark, thick layers of pine needles or other materials that can easily carry fire.

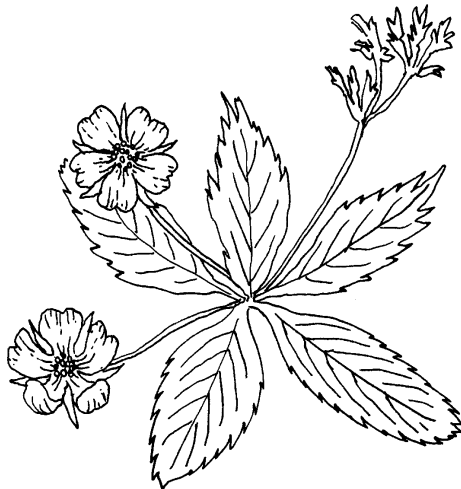

## Don't Forget Maintenance

A landscape is a dynamic, constantly changing system. Plants considered “fire resistant” and that have low fuel volumes can lose these characteristics over time. Your landscape, and the plants in it, must be maintained to retain their FireWise properties.



FIREWISE is a multi-agency program that encourages the development of defensible space and the prevention of catastrophic wildfire.

Be aware of the growth habits of the plants on your land and of the changes that occur seasonally. Keep a watchful eye for the need to reduce fuel volumes and fuel continuity.

- Remove annual, herbaceous plants after they have gone to seed or when the stems become overly dry.
- Rake up and dispose of litter as it builds up over the season.
- Mow or trim grasses to a low height within your defensible space. This is especially important as they begin to cure and dry.
- Remove plant parts damaged by snow, wind, frost or other agents.
- Timely pruning is critical. It not only reduces fuel volume but also maintains healthier plants with more succulent, vigorous growth.

## Additional FireWise Publications

### Colorado State University Extension

The following publications are available from The University Resource Center, 115 General Services Bldg., Fort Collins, CO 80523-4061; (970) 491-6198; resourcecenter@ucm.colostate.edu. Printed copies cost \$1; they are available free on our website at [www.urc.colostate.edu](http://www.urc.colostate.edu):

- 6.302, *Creating Wildfire-Defensible Zones*
- 6.303, *Fire-Resistant Landscaping*
- 6.304, *Fire Safety, Evacuation and Home Defense*
- 6.306, *Grass Seed Mixes for the Reduction of Wildfire Hazard*
- 7.402, *Protecting Trees During Construction*

### Colorado State Forest Service

The following publication is available from the Colorado State Forest Service, Colorado State University, Fort Collins, CO 80523-5060; (970) 491-6303:

- *Home Fire Protection in the Wildland Urban Interface*, CSFS #142-399



This fact sheet was produced in cooperation with the Colorado State Forest Service.

<sup>1</sup> *Wildfire Hazard Mitigation Coordinator, Colorado State Forest Service.*

Colorado State University, U.S. Department of Agriculture and Colorado counties cooperating. CSU Extension programs are available to all without discrimination. No endorsement of products mentioned is intended nor is criticism implied of products not mentioned.

## **Appendix F**

### **Cheatgrass and Wildfire**



## Quick Facts...

Cheatgrass (downy brome) is a noxious weed that can invade grassland communities and displace native plants; it thrives in disturbed areas.

This weed can produce more than 10,000 plants per square yard and is highly flammable.

Cheatgrass can be controlled mechanically, biologically, chemically, or by applying fire under controlled conditions.

**Colorado  
State**  
University

**Extension**

© Colorado State University  
Extension. 5/07.  
www.ext.colostate.edu

# FORESTRY

## Cheatgrass and Wildfire

no. 6.310

Adapted with permission from University of Nevada Cooperative Extension publications FS-05-29 and SP-05-08<sup>1</sup>

### Cheatgrass and Wildfire - A Dangerous Combination

Cheatgrass (*Bromus tectorum*), also known as downy brome, is an annual plant native to Eurasia. This aggressive, invasive weed was originally introduced into North America through soils brought by ocean-going vessels and is now a dominant species in the Intermountain West.

Cheatgrass often occurs as a significant component of foothills rangeland vegetation along the eastern front of the Rocky Mountains. While cheatgrass is usually found along roadsides and disturbed sites in the east, it is highly abundant in the west and has invaded disturbed and undisturbed grassland communities to become the dominant species in many lower-elevation areas.

Its destructive habits have placed it on Colorado's noxious weed C list. As with most non-native species, cheatgrass lacks biological predators in North America, providing it a helpful advantage over native species in competition for nutrients, sunlight, and water.

Cheatgrass is notorious for its ability to thrive in disturbed areas—common disturbances include construction, fire, floods, poor grazing activities, and intense recreation. But, it also will invade undisturbed areas. Cheatgrass is hard to control once it becomes established. As this invasive weed begins to dominate an area, it alters native plant communities and displaces native plants thus impacting wildlife. Additional negative impacts include changes in soil properties, a decline in agricultural production, and altered fire frequencies. Cheatgrass is highly flammable and densely growing populations provide ample, fine-textured fuels that increase fire intensity and often decrease the intervals between fires. If fire should strike cheatgrass-infested land native plant communities can be inextricably altered. This may result in erosion and damage to water resources.



Figure 1. Illustration of cheatgrass. From USDA-NRCS PLANTS Database/Hitchcock, A.S. (rev. A. Chase). 1950. *Manual of the grasses of the United States*. USDA Misc. Publ. No. 200. Washington DC.

### How to Identify Cheatgrass

Cheatgrass is an annual—it lives for only one year/growing season and then dies. It reproduces by seed and is termed a winter annual because its seed germinates from fall into winter. The plant reaches maturity in the spring and turns brown and dies with the onset of summer.

The height of cheatgrass ranges from three to 30 inches. It has a crooked seed head and small soft hairs covering the entire body of the plant. Leaves emerge dark green with a hint of purple. As it matures and begins to cure, cheatgrass turns yellow to reddish-brown in color with seed heads ranging from two to six inches long at maturity. These seeds have wedged awns that may be dispersed by wind and water, but most often they are spread by adhering to clothes or to the coat of a wild or domestic animal.

## Fire Hazards

The early-season growth habits of cheatgrass provide a competitive advantage by allowing it to grow tall and abundant before native species emerge. During years of high precipitation, this grass can produce more than 10,000 plants per square yard. Cheatgrass turns brown and dies by early summer leaving behind thick, continuous dry fuels and creating extreme wildfire hazards.

Though several components can affect flame length and fire spread, a typical cheatgrass fire on flat terrain with wind speeds of 20 miles per hour may generate flame lengths up to eight feet in height; the fire can travel more than four miles per hour. Grass fires are dangerous because they move quickly and grasses act as ladder fuels igniting larger and more volatile vegetation.

Due to these readily combustible characteristics, it is critical for those who live, play, or work in “cheatgrass country” to know not only how to identify and eradicate it, but also take precautions not to ignite it:

- Keep vehicles on well-maintained roads at all times. Fires can ignite as a result of hot car exhaust systems coming in contact with tall, dry fuels.
- Build campfires on bare ground in contained or designated areas. Make sure campfires are out completely before you leave.
- During hunting season or target practice, be aware of fires that may ignite due to stray bullets hitting solid objects and thus creating sparks.
- Supervise hay-baling and wheat harvesting operations closely to prevent ignition of dry fuels.
- Dispose of cigarette butts and matches properly.
- Use and maintain approved spark arresters on all power equipment.
- Keep an eye out for rocks and metal when brush hogging or mowing; sparks generated could start wildfires.
- Monitor sparks when using welding equipment. Have a fire extinguisher available.
- Instruct children to never play with fire or fireworks.

## A Concern for Homeowners

Cheatgrass is highly flammable and therefore a concern for homeowners. Clear this grass from within the area 30 feet immediately surrounding your home. Cheatgrass can act as a ladder fuel to ignite larger fuels; these can, in turn, throw burning embers and pose an even larger threat. Grass should be mowed to a minimum of six inches or less. Keep yards clean and green. Perform routine vegetation maintenance around your home and high-value property areas to mitigate potential problems.

## Control Methods

Cheatgrass can be controlled mechanically, biologically, chemically, or by applying fire under controlled conditions. The best results usually come from a combination of some or all of these techniques. The key to eradicating cheatgrass is diligence—once you begin the process you must be persistent and continue follow up treatments for up to four or five years (or however long it might take) because cheatgrass seed may survive in soils this long.

## How can homeowners eradicate cheatgrass?

Cheatgrass can be removed by hand pulling or mechanical techniques (i.e., a lawn mower, weed whacker, disking); remove the grass before it has time to mature, produce seed, and cure (turn brown and die). Once cheatgrass has been removed, rototill the soil to a three inch depth. Plant the area with desirable species, water properly, and maintain.

### Mechanical Treatments

**Hand pulling** – during spring and fall; repeat when new plants appear; effective in small areas only.

**Disking/tilling (live plants)** – spring and fall before the seed heads turn purple; repeat when new plants appear; use disk, rototiller, spike-tooth harrow, etc.

**Disking/tilling (seeds)** – once in late spring before seeding with desirable species in the fall; bury seeds at least three inches deep to prevent germination.

**Mowing** – not recommended as a long-term control technique as seed may be produced by mown plants.

### Biological Treatments

**Livestock grazing** – graze, very heavily, twice in early in spring (approximately three weeks apart) when the grass is green but prior to seed formation; repeat for at least two years.

### Chemical Treatments

A few chemical formulations exist, such as Plateau or Roundup, that may control or even eradicate cheatgrass. However, before using any chemical make sure that the herbicide label lists cheatgrass; if it is not listed, do not use. No one herbicide will control all weed species. Combinations of herbicides may be required for control. **As always, follow all instructions on the label.** For more assistance with chemical cheatgrass control, contact your county weed office or your local Colorado State University Extension office.

**Controlled Burning Treatment** – late spring and summer; controlled burning has associated risks which should be addressed in a prescribed burn plan. If not done correctly, prescribed burns may escape control and become wildfires, produce smoke that impairs visibility on highways or impacts individuals with respiratory problems, and may cause damage to desirable vegetation. Consultation with a prescribed fire/controlled burn specialist is recommended when developing a prescribed burn plan. Prescribed burn plans may require local and/or state burning permits. Contact your county sheriff or local fire official prior to burning.

#### **For More Information**

To learn more about cheatgrass and proper control methods contact your county weed district or Colorado State University Extension office.

Colorado State Forest Service, Colorado State University, Fort Collins, CO 80523-5060; (970) 491-6303; <http://csfs.colostate.edu>

Colorado State University Extension, 115 General Services Building, Fort Collins, CO 80523-4061; (970) 491-6198; E-mail: [resourcecenter@ucm.colostate.edu](mailto:resourcecenter@ucm.colostate.edu):

- 6.303, Fire-Resistant Landscaping
- 6.304, Forest Home Fire Safety
- 6.305, FireWise Plant Materials
- 6.306, Grass Seed Mixes to Reduce Wildfire Hazard

<sup>1</sup>J. Davison, central/northeast area plant and soils specialist, University of Nevada; E. Smith, western area natural resource specialist, University of Nevada Cooperative Extension. Colorado adaptation by G. Beck, Colorado State University Extension weed specialist and professor, department of bioagricultural sciences and pest management.

## **Appendix G**

### **Firewise Construction Design and Materials**

# Firewise Construction

DESIGN AND MATERIALS



Colorado  
State  
FOREST  
SERVICE





# Firewise Construction

DESIGN AND MATERIALS

**Peter Slack**



First edition printing, 1999

Revised printing, 2000

To obtain copies of this publication contact the  
Colorado State Forest Service at  
970-491-6303 or online at [csfs.colostate.edu](http://csfs.colostate.edu)



## About the Author

Peter Slack of Boulder, Colorado was a practicing architect for 26 years, until his untimely death in June 2000. Peter's practice included many homes and other buildings in the Interface. His design emphasized the integration of fire-resistive elements with other important design principles such as proper site development for limited impact, low energy and water consumption, and the use of appropriate, resource conserving materials.

Peter was a firefighter and an officer in a high-risk mountain fire district for 19 years. He specifically worked with wildland fire suppression and mitigation issues for much of that time. After fighting Boulder County's two major interface fires, Black Tiger, 1988 and Olde Stage, 1990, Peter participated in Boulder County's WHIMS Program (Wildfire Hazard Identification and Mitigation System). FEMA funded the WHIMS program as a result of those fires. This publication is developed from a lecture on firewise construction that Peter presented for several years.

## Acknowledgements

This publication combines Peter's professional knowledge as an architect and builder in the Interface with his experience as a firefighter for 19 years. Added to his experiences is the wealth of information and experience so generously given by the firefighting community. Most of all, it was their assistance in learning to visualize fire in its environment and around our buildings that facilitated the creation of these illustrations.

The following people contributed to this pamphlet by providing a wealth of information.

Dr. Claire Hay, consultant, Wildfire Interface Group

Mark Mulinex, Wildland Fire Coordinator, City of Boulder Fire Dept.

Mike Tombolato, chief, Cherryvale Fire Protection District

The many members of the Boulder County WHIMS program, who over many years have developed, to this date, one of the most comprehensive and systematic approaches to understanding the hazards of wildland fire to homes in the Interface.

The following people helped make this publication possible. They were responsible for choosing the author and providing additional technical details and editing:

Frank C. Dennis, Colorado State Forest Service

Fred Sibley, Office of Emergency Management, State of Colorado

The following people assisted in the production of this document:

Karen Gerhardt, Westerly Design, layout and design

Chris White, Wildfire Mitigation Coordinator, Boulder County

Gillans Engineering, Colorado, editing, second printing

Jill Croft Slack, editing and support

# Table of Contents

<b>1. Introduction: .....</b>	<b>1</b>
What is the Wildland Urban Interface?	
Fire suppression and increased fuels	
How can we protect our buildings?	
Fire intensity and duration related to the fire resistance of a house	
Evaluating fire hazards	
<b>2. Fire Behavior: Fuels, Topography and Weather .....</b>	<b>5</b>
Wildland fires and burning structures	
Vegetation is the fuel for wildland fires	
Fire duration and fuel	
Fire behavior and slope	
Fire behavior, ignition of fuels: mechanisms of heat transfer	
Convective lifting	
indirect: convective heating	
radiant heating	
Direct contact or impingement	
Weather	
<b>3. Building Site Location .....</b>	<b>9</b>
Topography and vegetation: fire behavior and intensity	
Aspect	
Dangerous topographic features: areas of more intense fire behavior	
Natural barriers and buffer zones	
How this affects building location and design decisions	
Site design and modifications to the forest: developing a defensible space	
<b>4. Building Design .....</b>	<b>15</b>
Simple vs. complex forms	
Aspect ratio	
Vents, eaves, soffits and decks	
Decks	
<b>5. Building Materials and Components .....</b>	<b>25</b>
Ratings	
Roofing	
Siding	
Windows and glass	
Doors	
<b>6. Summary .....</b>	<b>37</b>
References and additional information	

# I. Introduction

This publication provides homeowners and builders in the Wildland Urban Interface with design and building techniques that can offer more protection from wildland or forest fires. The Federal Emergency Management Agency (FEMA), the Colorado State Forest Service and the Colorado Office of Emergency Management funded this project.

## What is the Urban Wildland Interface?

The Urban Wildland Interface, or Interface, is any area where man-made buildings are built close to or within natural terrain and flammable vegetation, where high potential for wildland fires exists.

During the past few decades, population growth in the Interface has increased. Subdivisions and other high-density developments have created a situation where a wildland fire can involve more buildings than any amount of fire equipment can possibly protect.

## Fire suppression and increased fuels

The past 100 years of wildland fire and suppression has created more vegetation for fuel.

As population in the Interface has increased, so too has the difficulty of protecting that population from wildland fires. When fires occur in the Interface, we put them out to prevent the destruction of homes. This creates a problem because forests have historically depended on fire to maintain good

health. Fire thins trees and brush and eliminates dead material. By suppressing fires to protect our homes and population, we have interfered with this natural process. Since natural fires are now infrequent, vegetation density has increased, which provides more fuel for fires. When fires do occur, the denser vegetation burns with more intensity, and the fire is more destructive and dangerous.

## How can we protect our buildings?

This publication offers a two-part approach to the problem:

1. Build more fire-resistive structures and
2. Reduce the hazards of forest fuels.

If we consider the specific needs of Interface structures, we can combine design elements and construction materials to build more fire-resistive structures. Our goal is to create buildings that can either resist fire on their own, or at least make it easier for firefighters to protect structures safely.

We recognize that building a fireproof structure, as we do in an urban setting, can be prohibitively expensive. This publication discusses how to consider a combination of cost effective strategies that increase the probability of a building surviving a wildland fire.



*Combustible house with no defensible space*

Solutions to problems in the Interface depend on a two-part approach: Make our buildings more fire resistive and manage the surrounding wildlands. If we leave the surrounding wildland in its current state, we need to build structures that are nearly fireproof. Fireproof structures are far too expensive to build. Conversely, trying to provide a defensible space large enough for a typical, combustibile structure may not be practical or desirable. Choosing the best combination of these two strategies for a particular site requires a basic understanding of wildland fire behavior.

Another goal of this publication is to give the homeowner and builder a better understanding of how buildings in the Interface ignite during a wildland fire. With this information they can make better choices when considering building techniques and materials.

When reading this publication keep in mind that fire is only one of many considerations during building construction. We are not suggesting that any one technique is absolutely necessary, or that you cannot use alternate materials or design elements.

Rather, we want to show you how an awareness of the unique issues facing Interface buildings can direct you toward a more comprehensive solution in the design process. Some design elements and materials may help mitigate fire hazards; and some may not. It is possible, however, to compensate for less appropriate fire protection choices and meet design goals.

### **Fire intensity and duration related to the fire resistance of a house**

How fire resistive should a house be? The answer to this question depends on the fire intensity, (how hot the fire burns), and the fire duration, (how long the fire will last a your site). If the fire hazard is low to moderate, only a few precautions may be needed. If the fire hazard is high or very high, most, or all, of the strategies we describe may be needed.

In Colorado, generally any area surrounded by natural vegetation faces some hazard due to wildland fires. In mountainous regions between elevations of 5,000 and 10,000 feet, hazard is increased due to topography and increased vegetation density. The next section discusses this in more detail.

## Evaluating fire hazards

A good way to determine the specific hazard rating at a site is to look at a fire hazard map or study located at the county building or land use department. The Colorado State Forest Service or your local fire protection district may also have information. If this information is not immediately available, use this short evaluation to determine a site's hazard level.

Note: We refer to this hazard rating throughout this publication with respect to design and material elements in building design.

This short evaluation is based on the Wildland Home Fire Risk Meter developed by the National Wildfire Coordinating Group ([www.nwccg.com](http://www.nwccg.com)).

Slope	Score
Level:	0
0° - 10°	1
10° - 20°	2
20° - 30°	3
30°+	4

### Vegetation

water, bare rock, irrigated lawn	0
grass, shrub, less than 2 feet tall, no trees	1
grass, shrub, less than 4 feet widely dispersed trees	2
dense young shrubs, no dead wood or trees	2
many trees, touching, some grass and brush	3
dense shrubs with some trees	3
thick, tall grass	3
dense evergreen trees with grass and shrubs	4
dense mature shrub with dead branches	4

**After selecting the appropriate slope and vegetation scores, add them together to determine the hazard rating.**

Scores	Hazard Rating
0	0
1 - 2	low
3 - 4	medium
5 - 6	high
7 - 8	very high



## 2. Fire Behavior: Fuels, Topography and Weather

### Wildland fires and the nature of burning structures

Wildland fires have been studied in great detail to help predict fire behavior. Anticipating the intensity, duration and movement of a wildland fire is very important for both firefighter safety, and as the basis of tactical decisions made during the suppression of a fire.

Understanding fire behavior, especially its intensity and duration at a building site, will help homeowners and builders decide how fire-resistive a house needs to be.

Three factors affect wildland fire behavior:

1. **The fuel for the fire.** The type, continuity and density of the surrounding vegetation provides fuel to keep the fire burning.
2. **The topography of the site.** The steepness of slopes and other land features affects the fire behavior.
3. **The weather.** Wind and humidity affect each fire.

### Vegetation is the fuel for wildland fires

The type and density of a specific plant determines how it will burn. Not all vegetation burns the same way. Some vegetation almost never burns; others burn at different times of the year; and some can burn almost anytime.

**Deciduous trees and bushes:** Trees such as aspen, cottonwood and mountain ash; bushes such as mountain maple and dwarf lilac usually burn only during severe droughts.

Bushes, such as the Gambel oak, serviceberry and sage, can burn either in the fall when leaves have changed or dropped, or when there is an extended dry period.

### Evergreen trees with resinous sap:

Pines, spruce and firs can burn any time of year. They usually burn during extended dry weather or high wind events.

**Evergreen bushes:** Cedar and juniper can also burn any time of year when conditions are dry.

**Grasses.** Grasses can burn any time of the year and only need a short dry period before they are receptive to fire. Grass is fire resistive only when it is very green or a good snow cover exists.

### Fire duration and fuel

Fire duration is how long a fire will burn at a particular site. The type of fuel and its density determines a fire's duration. For example, grass is a light fuel. It will burn in less than five minutes and produce relatively less heat than heavier fuels would produce. Medium fuels, such as brush, burn five to 10 minutes with more heat. Large trees are considered heavy fuels because they burn from 10 minutes to over an hour with the most heat.

Understanding this is very important to determine how long a house must



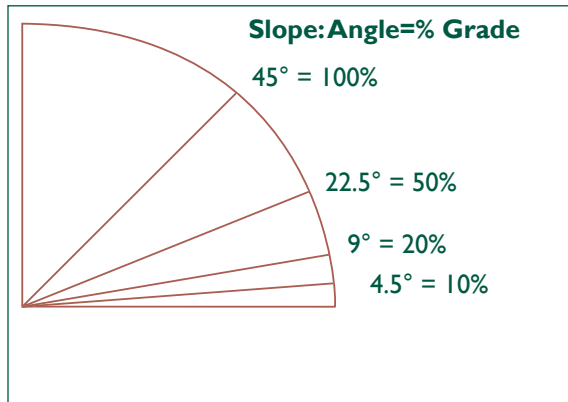

Slope chart

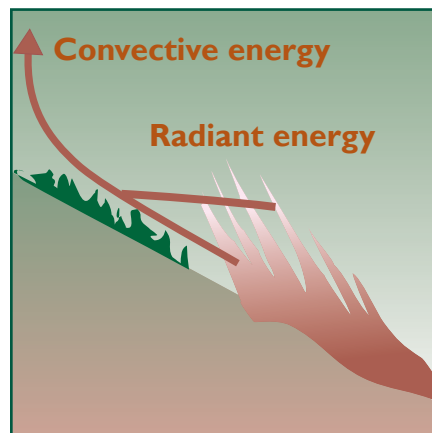

Convective and radiant energy from a fire

resist a fire. Different building materials can resist fire for different time periods.

### Fire behavior and slope

Slope is the angle of the ground relative to the horizon. It is commonly measured in either degrees or as a percent. Slope topography shows the steepness of the slope and the shape of the land.

The steeper the slope, the more quickly a fire moves and the hotter it burns.

For example, **a fire will spread twice as fast on a 30 percent slope than it will on level ground.**

This means that a house located on a steep slope needs more fire resistance.

### Fire behavior, ignition of fuels: mechanisms of heat transfer

As a fire burns, it releases hot gas and air from the combustion of burning vegetation or buildings. These gases move up the slope, drying and preheating any vegetation in the fire's path. The fire also releases large amounts of radiant energy, like that of the sun, which also heats and dries the fuels. Once flames make contact with these plants, they ignite more easily. This in turn speeds up the rate at which the fire moves and increases its intensity. Look more closely at the mechanisms of fire and how fire ignites a building by studying three categories of heat transfer:

1. indirect convective heating and lifting
2. indirect radiant
3. direct contact or impingement.

## Convective lifting

Fire produces hot gases that rise and carry partially burned substances and smoke into the atmosphere. During a wildland fire this atmospheric effect can be very strong, even causing its own wind as cooler air rushes in to replace the rising hot air.

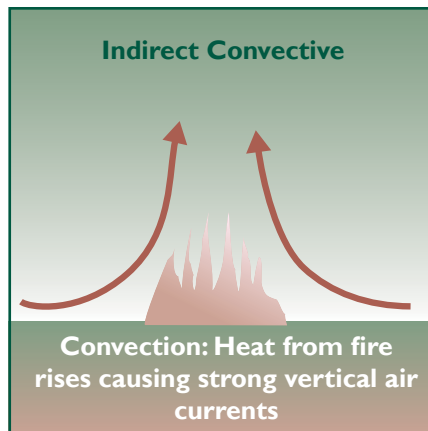

Convective lifting

Convective vertical air currents can also lift burning materials or embers, called firebrands, and carry them horizontally for long distances from the fire.

Once out of the rising air currents, firebrands fall back to the ground and onto horizontal surfaces such as combustible roofs, decks and dry vegetation around a house. This effect, called spotting, can be very widespread. Firebrands often travel hundreds or even thousands of feet in front of the actual fire.

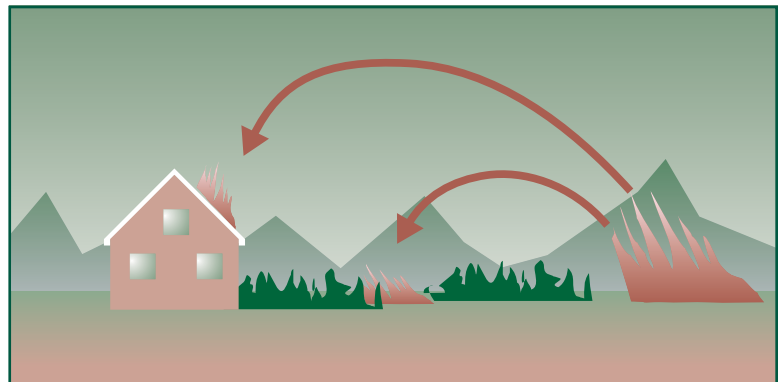

Firebrands, transported by convective lifting, create spot fires

## Indirect: Convective Heating

The same hot air and gasses that dry and preheat vegetation do the same thing to a building, making any combustible materials ready to ignite once the fire gets closer.

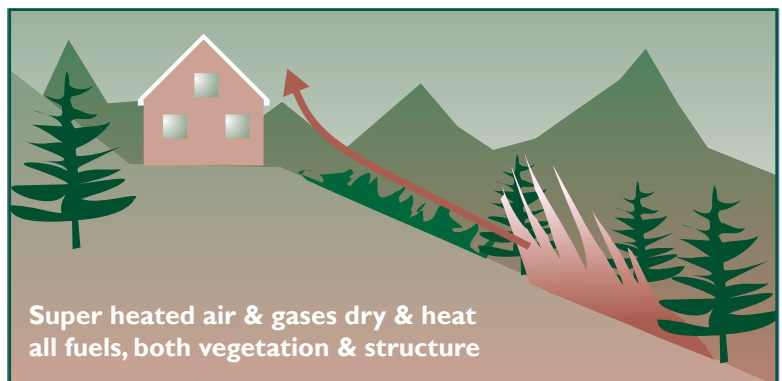

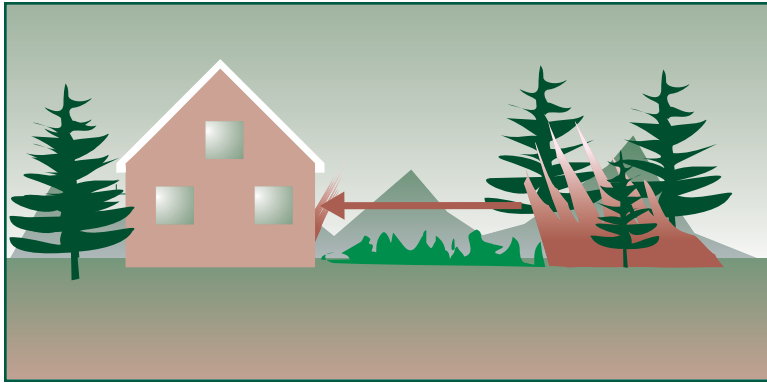

*Radiant heating*

### Indirect: radiant heating

Buildings can be preheated, even ignite and burn, from the transfer of heat by radiant energy from the fire. This is similar to sunlight heating objects, but fire heats only in the infrared portion of the light spectrum. Radiant heat transfers on a straight line of sight and can be reduced by barriers.

Vertical surfaces, such as siding, can ignite from this effect well before fire actually reaches the building. Large heavy fuels, once ignited, burn with high temperatures that amplify radiant energy, creating more potential for ignition through heat transfer.



*Fire directly impinging on a house*

### Direct contact or impingement

Continuous and abundant fuels like those found in unmanaged vegetation areas provide a direct path for a fire to contact a building. Creating defensible space and fuel breaks around a building is specifically intended to reduce this effect.

### Weather

Weather is a major factor affecting fire behavior and is, of course, highly variable in terms of time, intensity and location. During extended periods of low moisture, the possibility of wildfire increases. Weather can also increase and intensify fire behavior when there is low humidity and high winds.

Colorado's fire season is highly variable. Typically, winter and spring have few

wildfires; summer and fall have more wildfires. However the period between winter and spring, after the snow has melted but the vegetation has not yet greened, is often a period of high fire occurrence.

Colorado typically has 50 to 100 days a year of critical fire weather when severe wildfires are possible. More "fire days" occur at lower elevations while fewer "fire days" occur at higher elevations.

### 3. Building Site Location

#### Topography and vegetation: fire behavior and intensity

The location of a structure will influence the intensity and duration of the fire to which it is exposed. As discussed in the fire behavior section, we know at any location how intense a fire will be; how long it will be there; and how fast it will travel, based on the surrounding topography and vegetation.

When choosing a site location or determining the level of fire resistance a building requires, the builder or homeowner should be aware of how the local vegetation and topographic variations affect fire behavior.

#### Aspect

Aspect is the direction that a site's slope faces. Vegetation varies widely between the extremes of south facing and north facing slopes.

South slopes tend to have the least vegetation in an area because they quickly dry out and have less available moisture for plants. Since there is less fuel on south facing slopes, fire burns with less intensity than on other slopes with more fuel.

East and west slopes generally have more vegetation than south slopes. They are more prone to drying out in the summer when the sun is high in the sky. Fire potential increases on these slopes during the summer season.

North slopes typically have the most dense vegetation because there is more water available for plants. The higher moisture content of the vegetation on north slopes means that fires occur there less frequently. However, when fires do occur, they burn with more intensity because there is more fuel.

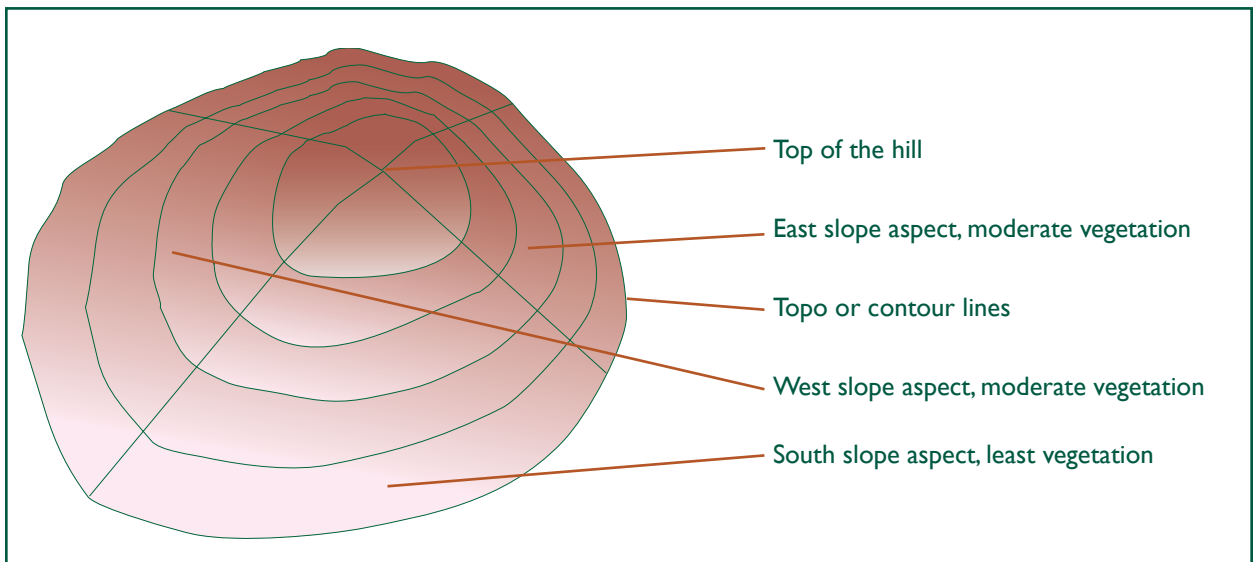

Aspect of slope

### Dangerous topographic features: areas of more intense fire behavior

Variations of topographic features such as valleys, ridges, canyons and saddles can be dangerous areas that further intensify or attract a fire.

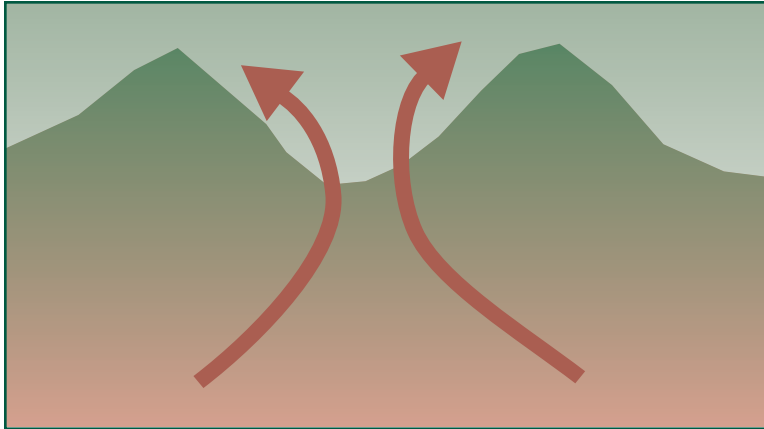

Saddle, low area on a ridge

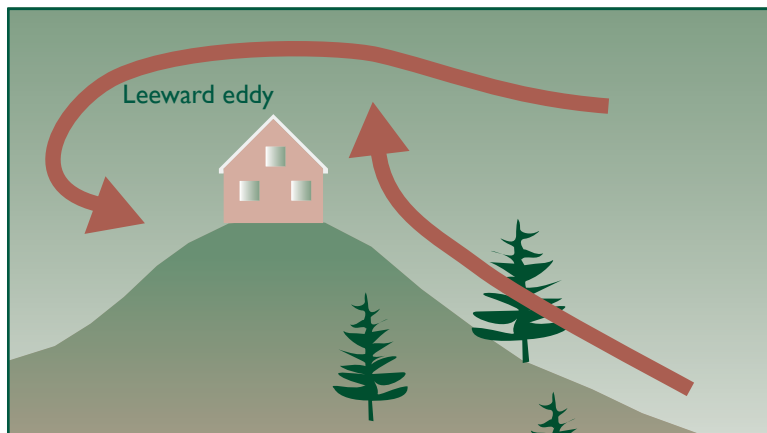

Ridge with wind exposure

A **valley**, as a concave form, tends to collect and concentrate winds. This means that a wildland fire's intensity increases as it moves through a valley. If the valley is narrow with steep sides, such as a **canyon**, this effect is more pronounced.

When a valley crosses a ridge it creates a **saddle** between the higher parts of that ridge. Like a valley, saddles will channel, intensify and speed up a fire. These areas tend to be built upon because they offer some shelter and often flat areas. It is important to recognize that saddles are natural fire paths where fire will travel first, and with more intensity.

**Ridges** experience more wind primarily because they are elevated above the surrounding land. When a fire moves up a slope toward a ridge, it gathers speed and intensity.

As the wind crosses a ridge it usually has a leeward eddy where the wind rolls around and comes up the leeward side, exposing both sides of the structure to wind and fire. There are usually no areas on ridges to provide protection from the fire.

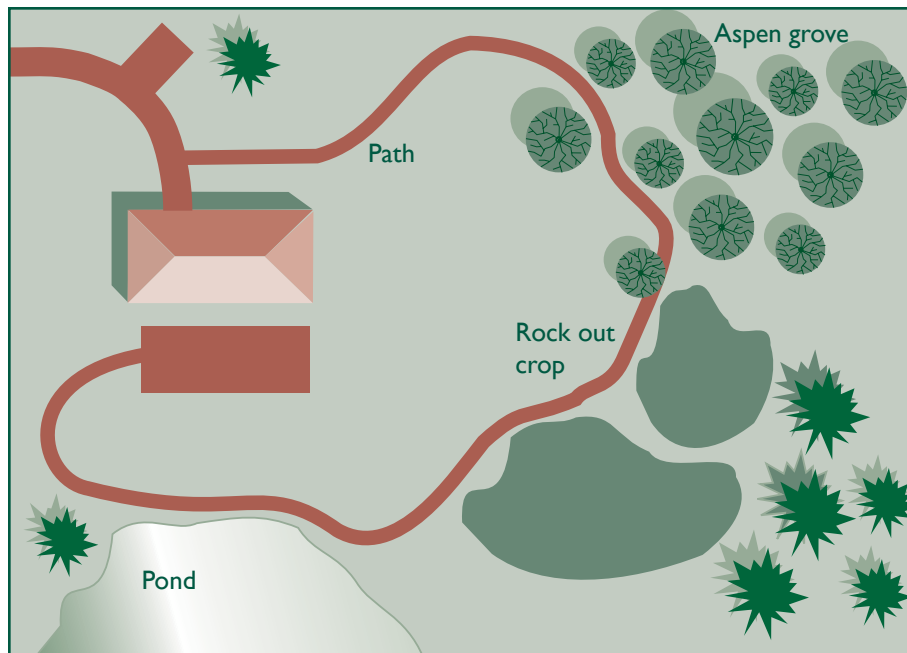

*Site: House located relative to natural features that buffer against fire*

## Natural barriers and buffer zones

Some physical features will reduce fire behavior and can be used to slow, reduce or deflect a fire. Some examples of these beneficial barriers are natural rock outcroppings, wetlands, streams, lakes and deciduous tree stands, (aspen, cottonwood, etc). Take advantage of these features by placing a building so that the natural barrier is between the building and the anticipated path of a fire.

the primary consideration will depend on how high the fire hazard is in the area.

On smaller parcels there may be only one suitable building location. The site's physical features will determine the probable fire intensity and dictate what combination of site modifications and fire-resistive construction is necessary to prevent the building from igniting.

## How this affects building location and design decisions

On large parcels of land consider these physical features when choosing the final location of a building. Many other factors such as privacy, views, access and aesthetic values will also effect site location decisions. Fire is just one of these factors. Whether or not fire is

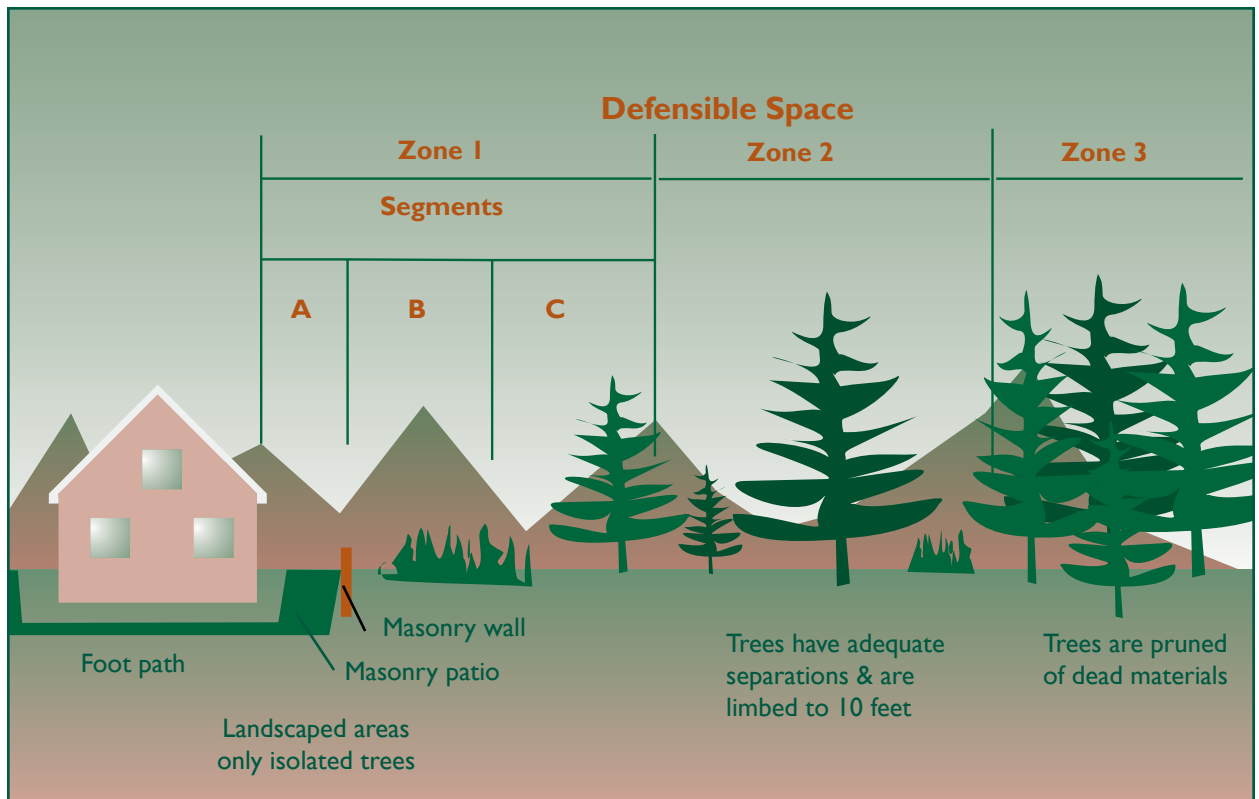

Defensible space

### Site design and modifications to the forest: developing a defensible space

After evaluating the fire hazard rating of a site, develop a plan to manage the surrounding forest and defensible space. This is the first part of our two-part strategy to build a fire-resistant structure. **Defensible space** is the area around a building that has been significantly modified to reduce a wildfire's intensity just enough to prevent the fire from igniting the house. The defensible space will also allow firefighters to more safely defend the house. It can also help prevent a house fire from spreading to surrounding vegetation.

A diagram of the features at a building site would show that moving away from

the building out into the wildland, the features gradually shift from man-made to more natural elements. We divide this gradation into zones. Developing a defensible space plan requires an inventory of the existing site features and analysis of how hazardous they are. Man-made elements are landscaping features such as masonry walls, patios, footpaths and driveways. These features create barriers and buffer zones.

The area next to the building (Zone I-A) should contain primarily noncombustible surfaces. Any planting in this zone should be only deciduous, well-trimmed and irrigated. Ground covers should be flowerbeds and cut grass.

Moving away from the building, the next area (Zone I-B) can have more

landscaping and less man-made surfaces. Vegetation should still be deciduous trees, bushes and grass can be native, but they must be kept trimmed to fewer than 6 inches tall.

Moving farther away from the building to (Zone 1-C) the landscaping should change from introduced deciduous plants to natural vegetation, including evergreens. These trees or bushes should be far apart and well maintained by trimming.

In Zone 2 the landscape is entirely natural vegetation that is intensely managed or modified. Trim dead material from natural vegetation closest to the buildings. Prune all limbs to 10 feet above the ground. Thin trees so that a minimum of 10 feet separates the tree crowns.

Moving vegetation farther away from the building into Zone 3, the forest management gradually becomes less intensive and subtler. Tree limbs need to be pruned only 4 to 5 feet above

the ground. Tree crowns can be closer together.

Remember, the more intensive and wide-ranging modifications you make in the defensible space, the less the need for fire-resistive materials and building design. Conversely, fewer modifications to the surrounding wildland increase the need to use fire-resistive materials and design for the building. These two strategies work together to achieve the goal of building a firewise structure that does not burn when wildfires occur.





## 4. Building Design

So far we have discussed elementary fire behavior and how to manage the wildlands surrounding an Interface building. The second part of our approach to building fire-resistive structures is learning about appropriate design and material choices.

### Simple vs. complex forms

Simple building forms have less surface area relative to the volume of the building. Complex building forms have much more surface area relative to volume. Simple building forms are less expensive to build, more energy efficient and easier to protect from wildland fires. There is simply less exterior surface to protect.

Complex forms not only increase the surface area of the structure, but also create shapes that trap the fire's heat. These areas are called heat traps. Transitions between vertical surfaces and horizontal surfaces, inside corners between two walls or abrupt intersections of different solid planes form pockets where wind velocity drops and eddies form.

Parapet walls, solar collectors, roofs intersecting walls, roof valleys and decks are examples of heat traps.

These forms cannot be avoided, and their locations require much more attention to fire-resistive materials.

When wind speed decreases burning embers falls most often at the locations described above.

Roofs are very susceptible to firebrands in a wind driven fire.

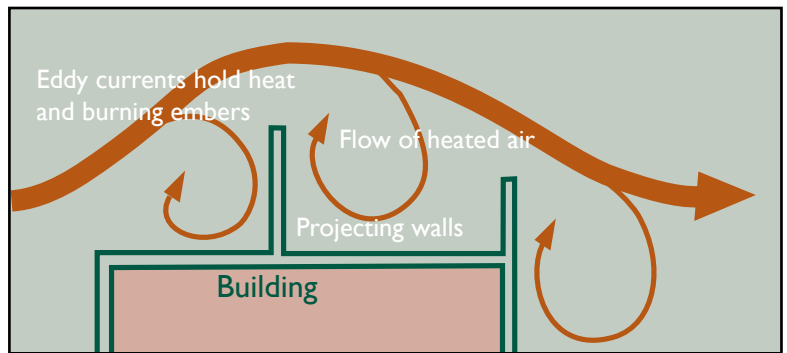

*Heat traps around walls*

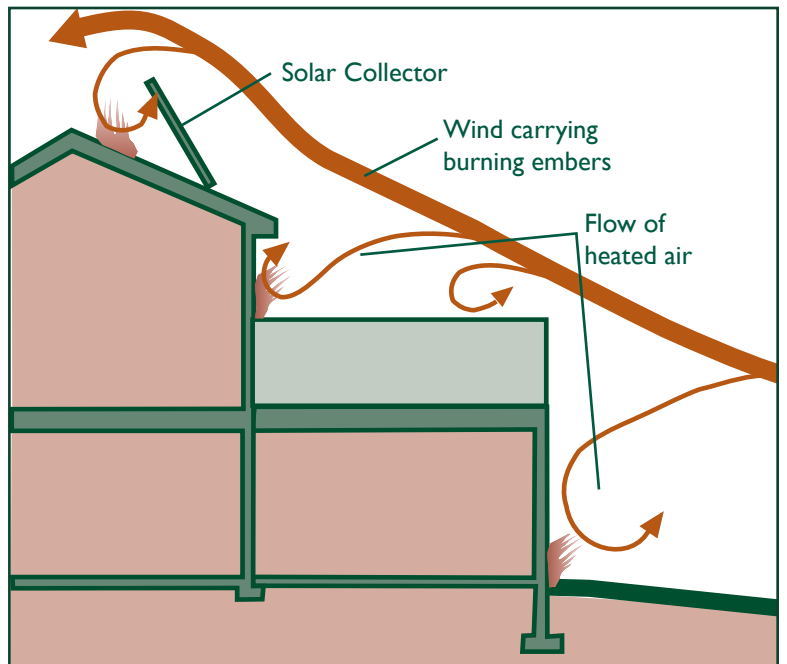

*Heat traps around roofs*

A simple roof form such as a hip or straight gable is best. Complicated roofs with intersecting planes and valleys form dead air pockets and eddy currents. The use of complicated forms further highlights the importance of a truly fire-resistive roof.

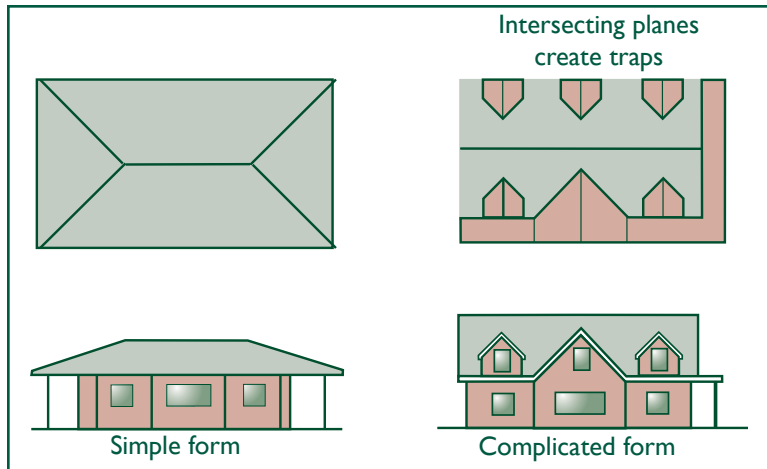

Roof forms

### Aspect ratio

Aspect ratio is the ratio between the east-west axis and the north-south axis. In Colorado’s climate it is generally better to have a structure that is longer on the east-west axis than the north-south axis. Such a structure has a more favorable energy relationship with the

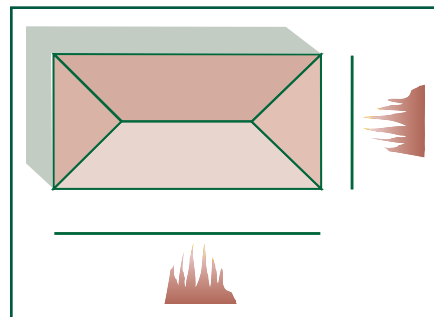

climate and can gain the benefits of the sun’s passive solar heat.

With regard to fire, if a house presents its widest exterior in the direction from which a fire is likely to come, it will be more vulnerable. More fire-resistant materials and components are needed on the side that faces the oncoming

fire. On a flat site the direction of a fire is somewhat unpredictable, but it will generally be determined by the predominant winds and fuel.

The probable fire path is more easily predicted on sloping sites. Fire can be expected to approach up the slope. On east and west facing slopes, placing the building on the longer east-west axis works well for both energy and fire considerations. The building presents its widest side to the winter sun and its narrowest side to the fire path.

Remember, a building can contradict these principles. In that case the building will require more fire-resistant building materials and components when simple forms and optimum aspect ratios cannot be used.

### Vents, eaves, soffits and decks

Building a fire-resistant house can be compared to building a watertight roof. One little hole in the roof allows water to leak in, and it doesn’t matter how well the job was done on the rest of the roof, it failed and damage occurred.

**Small building elements like soffits and vents can be the weak link in a fire. An otherwise fire-resistant house is damaged or destroyed because fire found a way in through these areas.**

### Vents

Vents are required by the building code to prevent accumulation of water vapor. All crawl spaces under wood floors are required to have ventilation. One square foot of vent is required for

every 150 square feet of floor area. Since these vents are typically located near the ground, care should be taken to not have any combustible vegetation immediately next to them.

Vents located on the downhill side of the house should have landscaping elements like stone patios or walls that block the direct path of the fire. Building codes typically allow alternatives to traditional vents. In some cases louvered vents are permitted. These can be closed when moisture is not a problem. (Fire season is usually the dry season.) Mechanical ventilation with intakes and exhaust located away from the ground or other vulnerable locations can also be used.

All attic spaces and roof cavities are required to have ventilation. One square foot of vent is required for every 300 square feet. of roof. (See eaves and soffits on page 18.) In both cases the vents should be made of metal with wire screen material that has 1/4 inch or smaller openings.

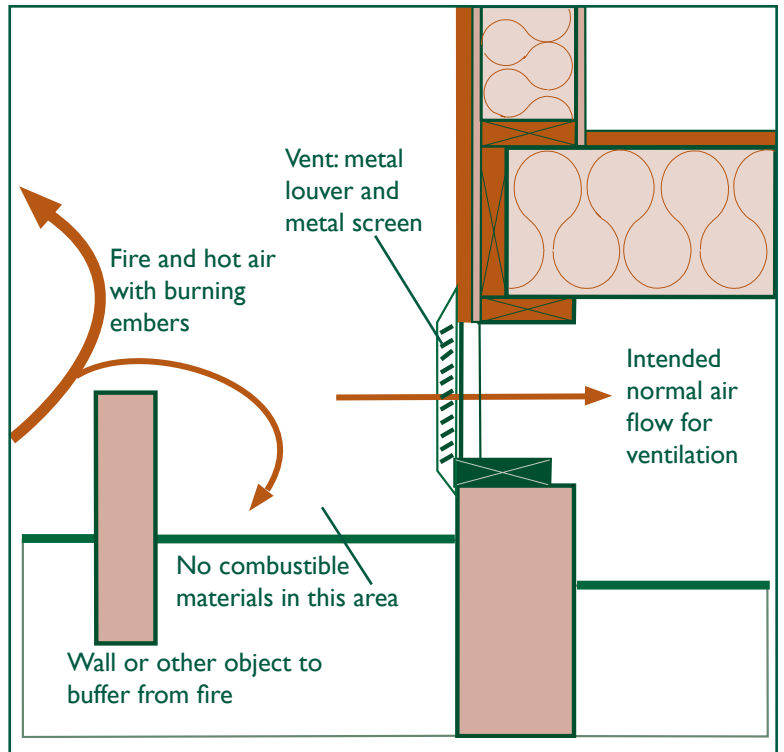

Crawl space ventilation

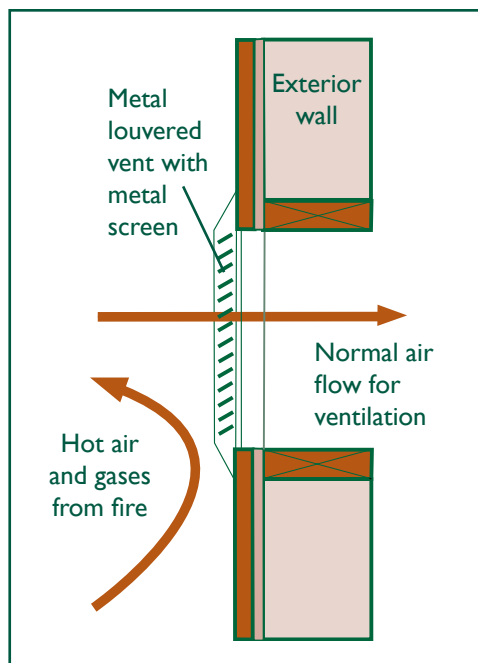

Attic Vent

## Eaves and soffits

The extension of the roof beyond the exterior wall is the eave. This architectural form is particularly prone to ignition. As fire approaches the building, the exterior wall deflects the hot air and gasses up into the eave. If the exterior wall is combustible this effect is amplified.

The solution is to cover the eave with a soffit. If the soffit is applied directly to the rafter eave, it forms a sloping soffit. This still makes a pocket that can trap fire.

A better detail is to form a flat soffit that allows the building to more readily deflect fire outward.

The soffit material should be at least 3/4 inch plywood in low fire hazard areas, noncombustible in moderate and high areas, and one-hour rated material in very high hazard areas.

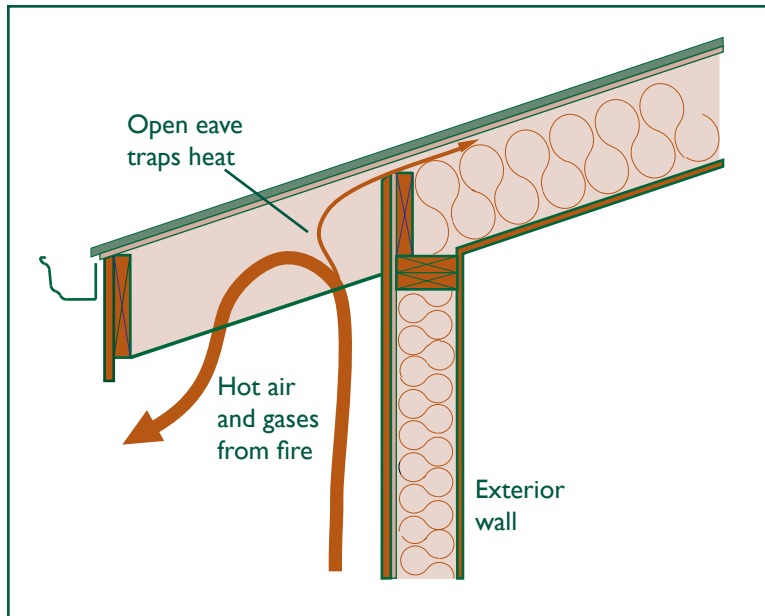

*Open eave with no soffit*

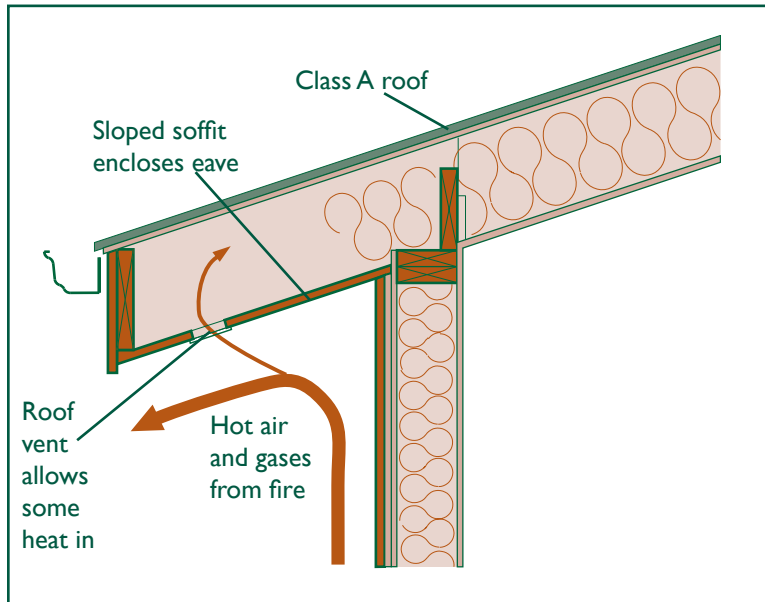

*Open eave with soffit*

Vents for roof ventilation are often found in the soffit. **Placing vents in these locations creates a perfect path for fire to enter the roof structure.** If the vent must be in this location it is better to place it farther from the wall and closer to the fascia. The vent can also be placed in the fascia or near the lower edge of the roof.

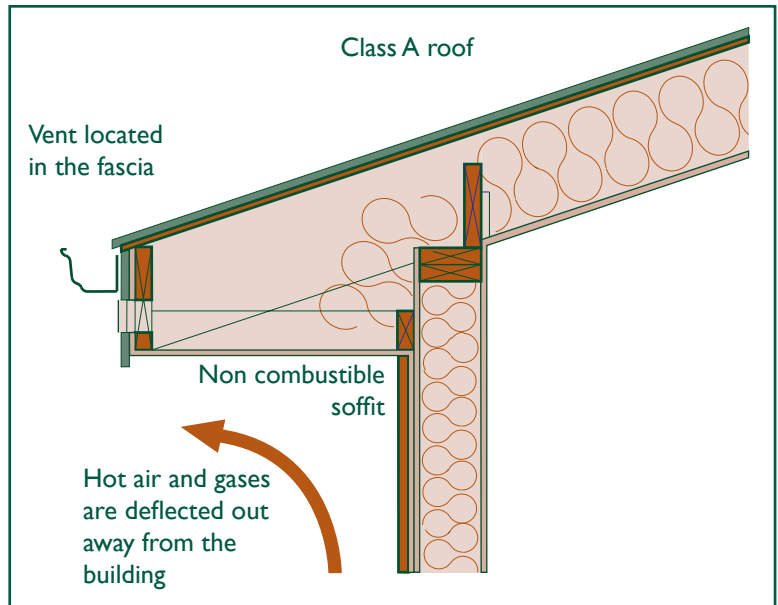

*Fully enclosed soffit with isolated vent*

## Decks

Decks are a very popular and well-used part of the house, especially in mountainous terrain. Because they provide elevation above the terrain and surrounding vegetation, they offer a better view. They also supply flat areas for walking on otherwise sloping terrain.

The problem is that most decks are highly combustible structures. They are the ultimate heat traps. Their shape traps hot gasses from an approaching fire. Decks often face downhill towards a fire's most likely approach up a slope.

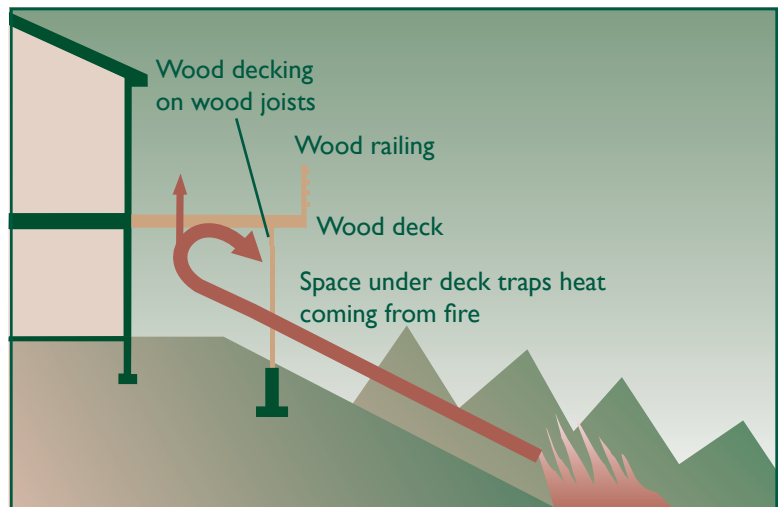

*Conventional deck in a fire*

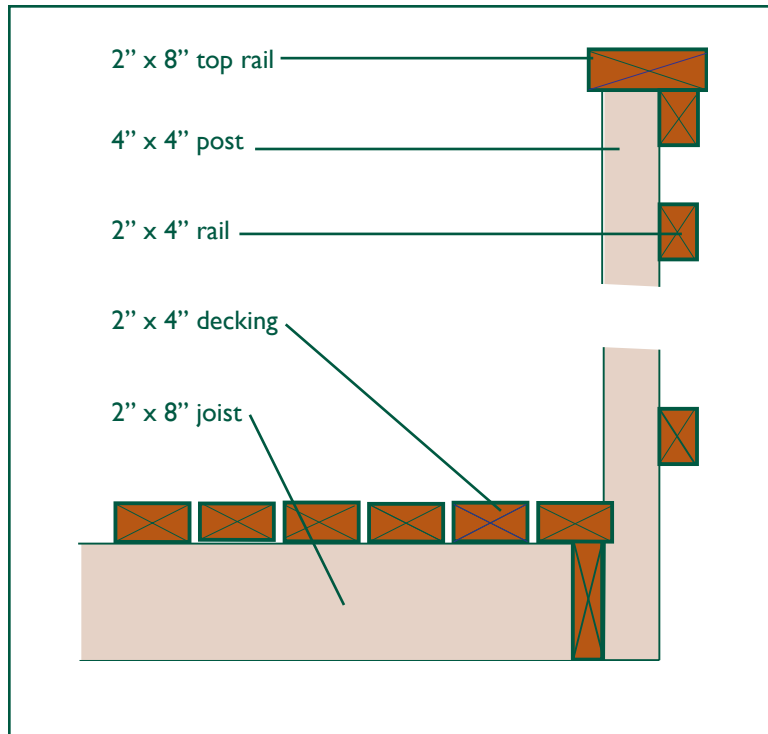

Conventional deck construction detail



Decks are built perfectly to burn, almost as easily as wood stacked in a fireplace. All the components of a deck; joists, decking and railings, are made of only 2 inch thick wood with a high surface-to-volume ratios.

When fire approaches, the wood quickly dries out and heats up. Ignition can occur very easily when either the radiant energy from the fire gets hot enough or a burning ember lands on it.

### Ignition of decks

Conventional wood decks are so combustible that when wildland fire approaches, the deck often ignites before the fire gets to the house. Sometimes unburned vegetation exists between the house and the fire, demonstrating that the deck was more flammable than the vegetation.

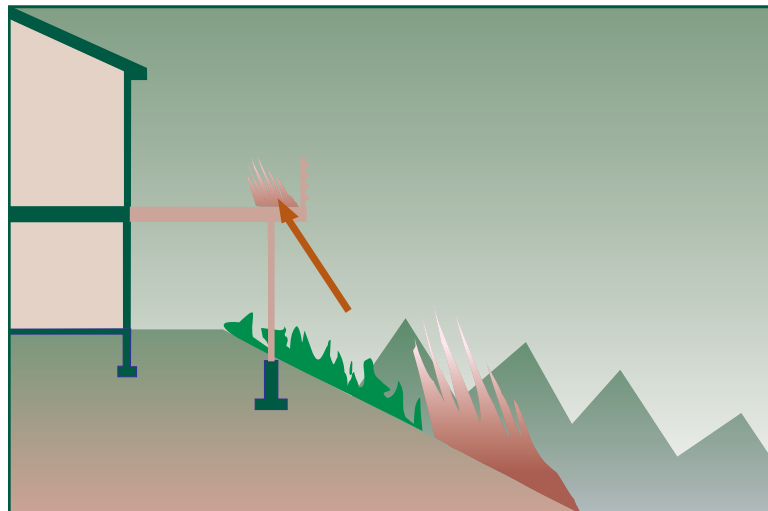

## Isolate the deck from the fire with a patio and a wall

In low and moderate fire areas, it may be sufficient to isolate the deck from the fuels and fire by building a noncombustible patio and wall below it. The patio will assure that no combustible materials are below the deck. The wall will act as a shield, deflecting both the radiant and convective energy of the fire.

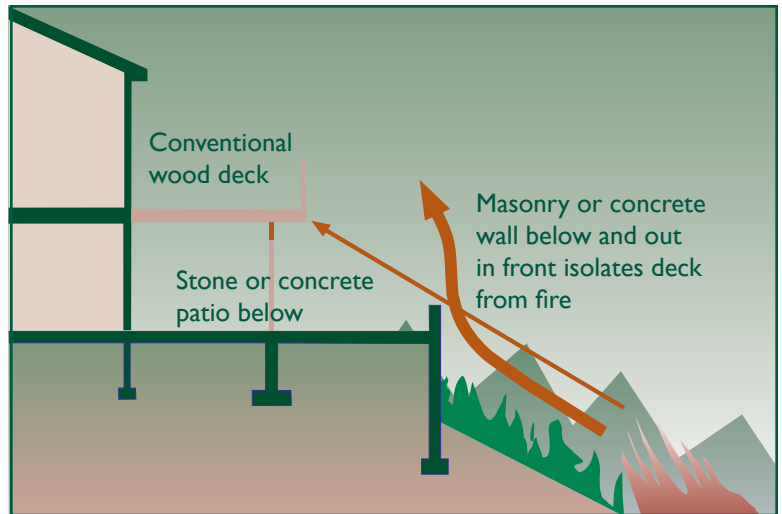

*Deck with a patio and a wall below*

## Heavy timber construction

In moderate hazard areas the use of heavy timber construction is acceptable. Like log siding, heavy timber is combustible but so thick that it burns very slowly.

Minimum thickness for a heavy timber deck is 6 inches for the posts and structural members and 3 inches for the decking and rails. This type of construction can be used with a patio below for additional protection.

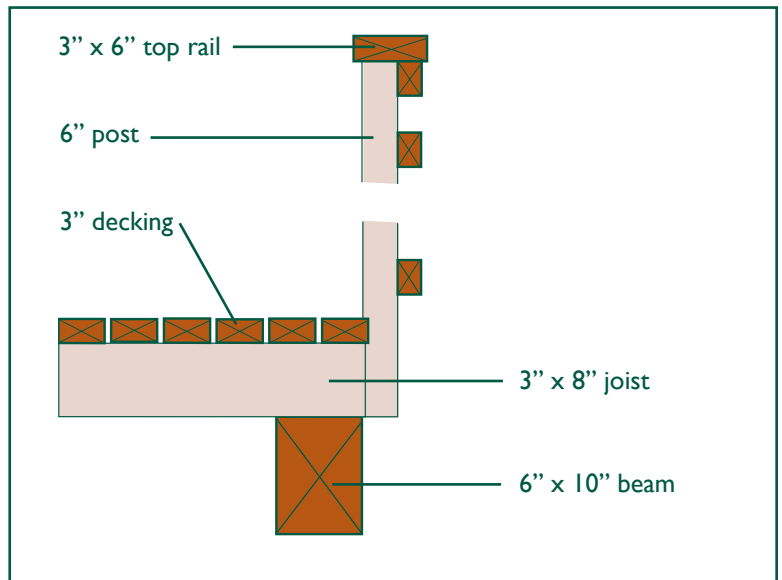

*Heavy timber deck*



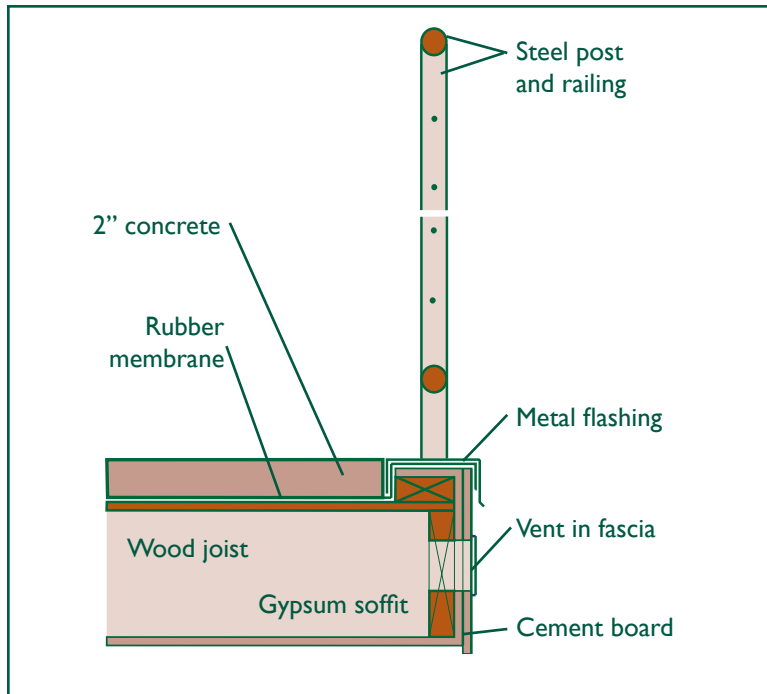

*Fire-resistant deck construction detail*

## Fire-resistant deck construction

In the highest fire hazard areas, consider noncombustible surfaces and fire-resistant building materials for a deck. Wood frame construction is permitted, but change the surface to noncombustible or one-hour rated materials.

To build this type of surface, place a waterproof membrane over the top of the deck. This allows the use of fire-resistant soffit materials, which cannot tolerate moisture. The most common materials are cement fiber panels or metal (noncombustible), or gypsum (noncombustible and one-hour rated).

Cover the membrane with decking. One suggestion is plastic wood which has low combustibility; it will burn but only very slowly. Better yet, use 1 to 2 inches of concrete or stone. This surface is fire-proof and protects the deck from air-born firebrands. However, this covering requires that the structure be strengthened to support the additional weight.

Posts and railings can be economically built from steel. Wood posts near the ground can have stone, brick, or noncombustible coverings. A popular baluster design is steel wire, but this is expensive. Steel pipe, usually 1 to 2 inches in diameter, is very economical and easy to work with. Square steel shapes can look like traditional wood railings.

## Fully enclosed decks

The best design is to convert the deck to a solid form by fully enclosing it. This completely eliminates the heat trap. This form also complies with the new Urban/Wildland Interface code (1997).



In the photo above, the deck is over the garage. It has a metal railing with heavy timber posts and concrete deck.

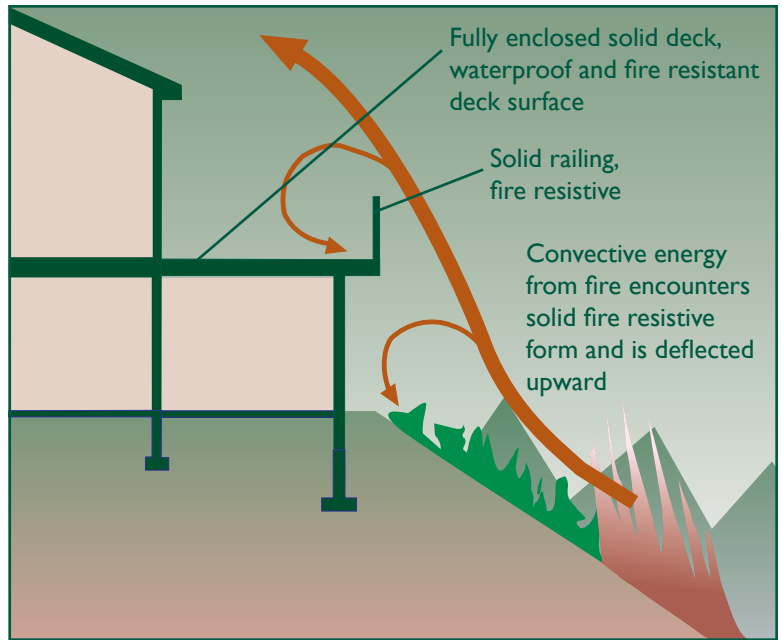

Fully enclosed solid deck



## 5. Building Materials and Components

### Ratings

When discussing building materials and components we make frequent references to ratings. Through testing various national organizations provide ratings or evaluations for the fire resistivity of materials or building assemblies. A building assembly is a combination of materials forming a component of a building such as a roof or wall. The ratings are in the following categories:

Combustible or noncombustible

Classes: A (best), B, and C

Time: 20 minute, one-hour, two-hour and four-hour

The organizations that provide these ratings are: the International Conference of Building Officials (ICBO) through its publication, the Uniform Building Code (UBC); Also a founding member of the International Code Council (ICC) through its publication the International Building Code (IBC); The American Society for Testing and Materials (ASTM); the Underwriters Laboratory (UL); and the National Fire Protection Association (NFPA).

The difference between a non-combustible material and a rated material or assembly is the surface resistance to ignition versus the protection afforded the building behind it. A good example of a non-combustible material is metal roofing and siding. Metal is non-combustible, but an excellent conductor of heat. If the fire remains present long enough, the heat will be conducted through the metal and ignite the material behind it. An example of

a fire-rated assembly is wood siding applied over gypsum sheathing. This assembly is rated as one hour. The surface can ignite, but the building is protected from the fire for one hour.

**The importance of this is the difference between intensity of fire and duration of fire as described in the fire behavior section.**

Most ratings are for commercial buildings in urban settings, but some apply to residential structures. For example, the wall between a garage and a house must be rated as one-hour fire resistive. The door between the garage and the house must have a “C label” rated for 20 minutes with an automatic closer.

Material ratings for the wildland fire environment have been directly addressed by the I.C.B.O, through a subsidiary, the International Fire Code Institute, Fire Service Division and its publication, the Urban Wildland Interface Code and N.F.P.A. Standard 299. These publications also address other issues covered in this publication such as access, utilities and water supplies for fire suppression. Much of what is contained in this publication is based on or refers to these publications.

## Roofing

Roofing is one of the most important ways to protect a house from wildland fire. As shown earlier, when wildland fires become more intense, the lofted firebrands become a significant cause of the fire spread. Since most roofing has a rough surface and numerous cracks, it can trap wind blown embers and firebrands. In all major Interface fires, houses thousands of feet from the fire have been observed with burning roofs.

## Wood shakes and shingles

Simply put, wood shakes and shingles are made perfectly to burn. They are almost like kindling. They are thin, 1/2 to 1 inch thick, with a very rough surface and many cracks. When a wood roof burns it also lofts burning embers, contributing to the spread of fire. Another important characteristic of wood roofs is that they dry out in Colorado's dry climate.



A cedar roof can be modified to be fire-resistant. Pressure treatment with chemicals can change wood shingles to a class B or C roof. Chemically treated cedar roofs built with a gypsum underlayment can have a class A assembly rating. However, many doubt that the testing conditions for these shingles matched Colorado's climate of low

humidity, high winds, elevated ultraviolet radiation and extreme temperature variations.

The use of wood shakes in the Colorado region is diminishing, not because of the fire risk they pose, but because of the unavailability of insurance coverage for damage due to hail and high winds. Cost wise, hail losses in Colorado are 10 times greater than fire losses.

## Asphalt shingles

Asphalt shingles are probably the most economical way to roof a building, especially in terms of dollars spent per years of guaranteed life. Conventional mineral reinforced asphalt shingles have been around for more than 60 years. They are normally guaranteed for 10 to 20 years, and usually have a class C rating.



Mineral reinforced shingles have gradually been replaced by fiberglass reinforced asphalt shingles. These offer guarantees of 20 to 40 years and are a class A material. They are available in many colors and textures and can even imitate wood or slate shingles.

## Metal: sheet and shingles

Metal roofing has always been available in sheet form in many colors. It usually has standing seams or ribs. The most common metal roof is galvanized steel with factory-applied paint (usually a two-part epoxy type, not too different from automobile paint).



Metal roofing is also available as an imitation wood shingle. This product is made by stamping a texture and shape on the metal and then applying the appropriate color. This imitation is so good that at a distance of 100 feet or more it is difficult to tell the difference between it and a wood shingle.

The advantage of metal roofing, both flat and stamped shingle, is that it is non-combustible, durable and very lightweight. It requires a gypsum underlayment in order to have a class A assembly rating, but that is only necessary in high or very high fire hazard situations. Guarantees start at 20 years and go to 50 years.

In addition to galvanized steel with paint, metal roofing is also available in aluminum with paint, stainless steel and copper. These tend to be more expensive but also last longer.

## Fiber-cement shingles

These shingles are made of cement and fiberglass, or cement and wood. Like the metal shingle, they are made to imitate a wood shingle's texture, shape and color. The cement in these products is altered with polymers to make it less brittle. These products are also noncombustible but require an underlayment for a class A assembly rating.

## Membrane roofs

These materials include both rubber and hot applied, bituminous saturated mineral felt for flat roofs. These materials are marginally combustible but are most often used with other covering systems like concrete. It can be applied over a gypsum underlayment for a class A assembly rating. Guarantees are only in the 10 to 20 year range, but these products can be considered permanent when covered with concrete.

## Concrete shingles and tile, slate shingles, clay tile

These products provide the best fire-resistive roof, but they are expensive. They are 1 inch thick, heavy (10 pounds per square foot), non-combustible, class A rated and usually come with 50 year guarantees. Concrete shingles are manufactured to look like wood shingles. When having a tile roof installed, pay careful attention to the closure of the round openings of the tiles at the edge of the roof.



## Exterior walls: siding

The exterior walls of a building are most affected by radiant energy from the fire and, if there is not enough defensible space provided, by the direct impingement of the fire.

## Wood panels and boards

Wood panels and boards are the most common and economical forms of siding, but they are readily combustible. This siding is usually not very thick, 1/2 inch to 3/4 inch, and will burn through to the structure behind it in less than 10 minutes. A one-hour rating can be achieved by adding gypsum sheathing behind the siding. However, this addition is of limited value because the building can still ignite, and the fire can spread to other parts of the building such as the eaves above the exterior wall or the windows.



## Fiber cement panels, boards and shingles

These products are non-combustible, but they may not be rated and may need gypsum sheathing to achieve a one-hour rating. These materials are very economical and cost just a little more than wood products. When these products are applied with the gypsum

sheathing they offer the most economical way to side a house that will resist almost all fire hazard conditions. These materials are virtually permanent on a vertical surface and come with a 50 year guarantee, but they need to be painted. Some can even take a stain with satisfactory results. These products are available with textures molded to imitate wood grain.

## Metal: galvanized steel,

aluminum, boards, panels and shingles  
Like their counterparts in roofing, these products are available in either flat sheets with seams, a stamped board or shingle that imitates a wood product. They are factory painted with two-part epoxy paint and usually have a 50 year guarantee. Unlike the fiber cement product, the paint on this product is a part of the guarantee; thus, it is an almost permanent, no-maintenance material. It is non-combustible, but like other metal products needs a gypsum sheathing to achieve a one-hour rating.

## “Real” Stucco

Real stucco, as base material, is 3/4 inch to 1 inch thick cement and gypsum. The stucco is applied in two or three coats with metal mesh reinforcing. The color is integrated into the final coat and thus lasts a very long time. Guarantees are 10 to 20 years. It is both a non-combustible and one-hour rated material, which makes it a very good material for high hazard areas. Real stucco tends to be expensive and is also prone to cracking if not applied absolutely correctly.

## Synthetic stucco, exterior

insulating finish system (EIFS)

This product is a 1/8 inch thick acrylic cement finish on fiberglass mesh. This is applied to the tap surface 1 to 2 inches of expanded polystyrene (EPS). The color, like real stucco, is in the cement coat and thus lasts a long time. This is the preferred way to do stucco because it takes less labor and is therefore cheaper. The foam insulation isolates the stucco finish from the building, which virtually eliminates cracking.

The surface is noncombustible and has no rating by itself. This product is interesting in a fire because it significantly delays a fire due to the insulation quality of the rigid foam and the fact that the system does not ignite; it actually fails and falls away. In moderate to high fire hazard situations this product will work well. It can, like other products, obtain a one-hour rating with gypsum sheathing, which should be used in a very high fire hazard area.

## Heavy timber or log construction

This wood product has a minimum thickness of 6 inches for frame members and exterior siding, and



3 inches for decking and steps. Heavy timber is recognized by building codes as a separate fire-resistive category.

Even though heavy timber is combustible, the low surface-to-volume ratio causes it to burn very slowly. This makes it very appropriate for medium and high fire risk situations.

## Concrete synthetic stone

These products are cast concrete with integral color forming the texture and shape of the stone being imitated. They are modular shapes that have consistent dimensions with flat backs, keeping labor costs down.



Synthetic stone is reinforced with fiberglass and steel mesh, making it very resistant to cracking. It is fully noncombustible and is usually rated as a one-hour material.

## Brick, stone and block

These materials are both permanent and fireproof. Ratings are usually two hours. These are the best products to use in regard to fire resistivity but are the most expensive.

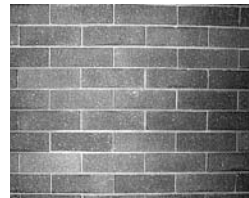



## Windows and Glass

Windows are one of the weakest parts of a building with regard to fire. They usually fail before the building ignites, providing a direct path for the fire to reach the building interior.

### Glass failure

Glass provides only a partial barrier to fire and only for a short time. It fractures in the presence of heat. In the case of a wildland fire, this will happen in about five minutes. Glass deflects most of the convective energy, but not the radiant energy of the fire.

Convective energy is hot air and gasses. About 70 percent of the heat is deflected by window glass; about 20 percent of the heat is absorbed; and 10

percent of the heat is transmitted to the interior of the building.

Radiant energy from a fire is infrared light energy, like the energy we experience from the sun. Most radiant energy from a fire, 60 percent, is transmitted through the glass to the interior of the building; about 20 percent is reflected; and about 20 percent is absorbed by the window glass.

Both the radiant and convective energy heats the glass, but the perimeter of the glass is covered and protected by a sash. This causes a differential heating and stressing of the glass, which causes it to crack.

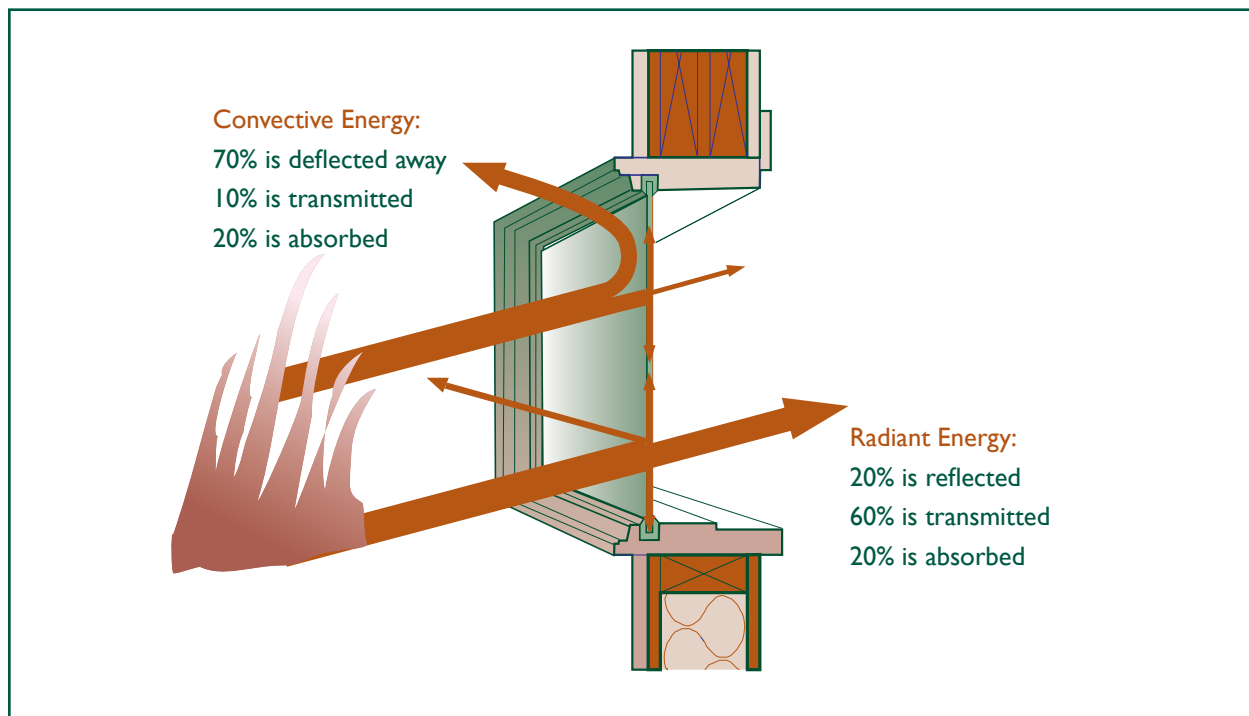

Energy transmission, conventional glass

## Large and small windows

Even if the glass does fracture, the hot gasses (convective energy) from the fire and the fire itself cannot enter the building if the glass stays in place. Only the radiant energy heat can get through. Eventually, even with the glass in place, combustible materials behind the window may ignite. (See Low E glass).

Small windows, less than 2 feet wide or tall on a side, will keep fractured glass in place. The size of glass held in place by the sash is relatively small with little weight.

Large windows (more than 2 feet wide or tall on a side) cannot keep the fractured glass in place. The size and weight of glass in relationship to the length of sash is too great.

## Thermopane or double glazed windows

Because of current energy codes, most glass today is double glazed or Thermopane. Double-glazed windows last about twice as long as a single pane, or about 10 minutes.

The same processes of convective and radiant energy affect the front pane of glass. As long as the front pane is in place, the second pane is partially protected. When the front pane fails and falls away, the process continues on the second pane until it fails and falls away.

As shown earlier in the fire behavior section, the duration of a fire at a site is dependent on the slope and the fuels. It can be as short as 5 minutes in the case of a grass fire.

If the duration of the fire is any longer than 10 minutes due to significant fuel

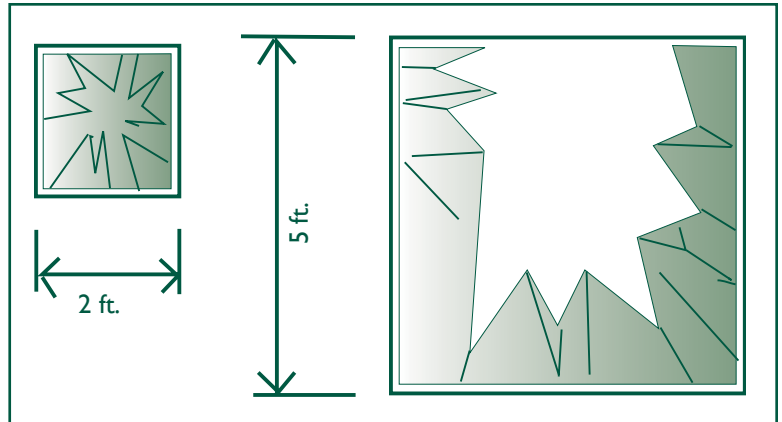

*Small and large windows*

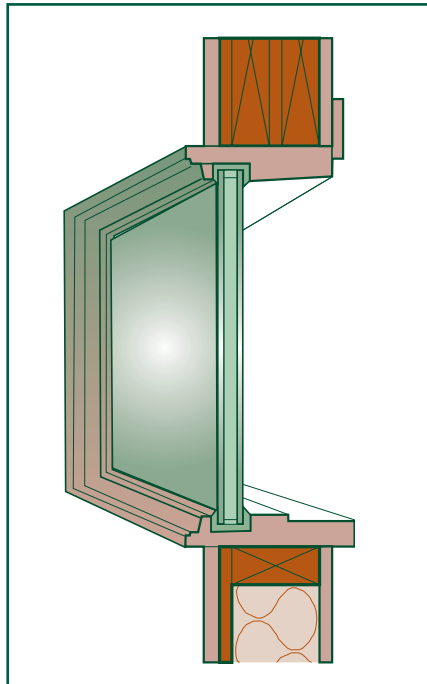

*Thermopane window*

supply around the house or preheating, additional protection will be necessary to prevent glass failure and fire entering the house.

## Exterior window covers, shutters and screens

Only an additional 10 to 20 minutes of protection is necessary for a window to survive most fires. Exterior window covers, such as in-place shutters, can add this time. Shutters originated in New England as protection from storms when the wind would break the glass. They are now readily available in the Southeast for hurricane protection.

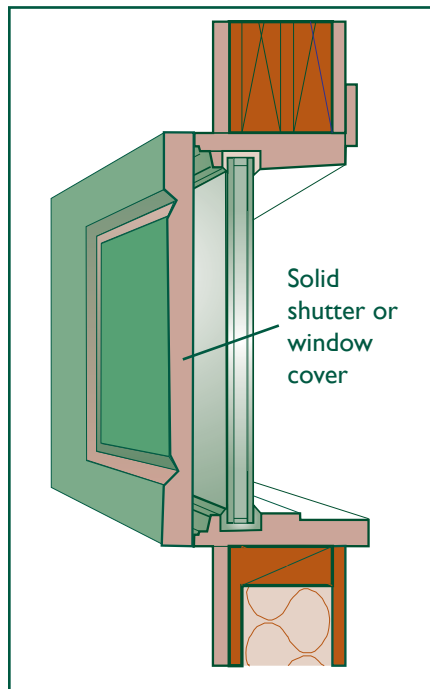

Wood shutters are the most common and economical, but they will ignite within five minutes. However, as shown in the fire behavior section, if the wildland fire duration is short enough, an additional five minutes of protection may be all that is needed. Also, even though fire departments may use foam to protect structures, it will not stick to glass. Therefore, shutters may still be advisable.

Metal shutters are better. They will protect the window long enough to last through the fire event and will not ignite.

The disadvantage of shutters is that they are not completely passive, that is, they require intervention on the part of the homeowner or the fire department to work.

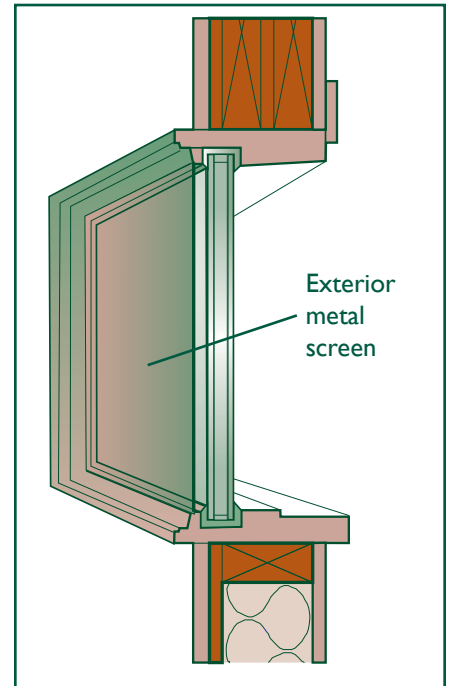

Permanently placed exterior metal screens eliminate the deployment problem. Exterior screens are not going to protect the window as much as a solid cover, but as mentioned before, only five to 10 minutes of additional protection may be needed. Screens also provide a surface to which foam can adhere. These screens cannot be used with outward acting windows, like casement or awning windows, but they can be used with horizontal sliding and double hung windows.

## Tempered glass

Tempered glass is both resistant to high impact and high heat. Most of us are familiar with it. Building codes require that tempered glass be used in patio doors and all areas subject to human impact. It is also the glass used in front of fireplaces. Tempered glass will stay in place and intact throughout the wildland fire event.

A problem with tempered glass is cost. Windows with tempered glass typically cost 50 percent more than regular glass. There are strategies around this, and costs are coming down.

Patio door replacement units are, as they infer, used to replace glass in patio doors. These units are mass produced and stocked by virtually every glass business. As a result they are very economical. In fact they are less expensive than conventional glass. They come in six sizes, as shown at right, and typically can be used as a picture unit, or combined to make a window wall or solar structure.

Using patio door replacement units provides a lot of tempered glass at a very economical price.

A few brands of windows are marketed as replacement windows in existing mid-rise urban buildings where the use of tempered glass is required. As a result, the additional cost for these brands of tempered glass is only 25 percent more than standard glass. Your local window supplier can suggest appropriate manufacturers.

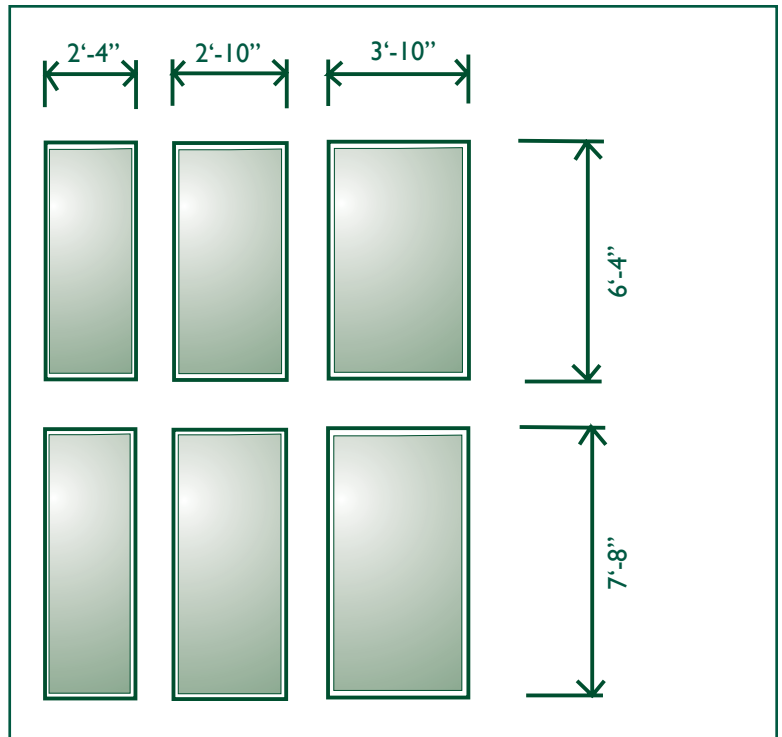

*Patio door replacement unit sizes*

## Low E glass

Low E stands for low emissivity. This is an ultra thin, several microns thick, metallic coating on glass that appears white or reflective to infrared and ultraviolet light. It is used in windows for energy efficiency because it holds more heat in during the winter and keep more heat out during the summer. It also protects fabrics from fading and wood from yellowing.

This glazing option is widely used in windows today and only costs about 10 percent more than standard double glazed units.

The advantage of this glass in a wildland fire is that it stops the radiant energy

transfer to combustible materials behind the glass such as drapes, wood furniture and walls.

The combination of Low E and tempered glass features for windows provides the best possible solution for windows in a wildland fire. The glass will stay intact throughout the fire event and will transfer less radiant energy to combustibles in the structure.

It should be noted that the use of tempered and Low E glass is a recommendation based on observations in the field. Actual laboratory studies in a wildland fire setting need to be conducted to give these types of glass specific quantitative values.

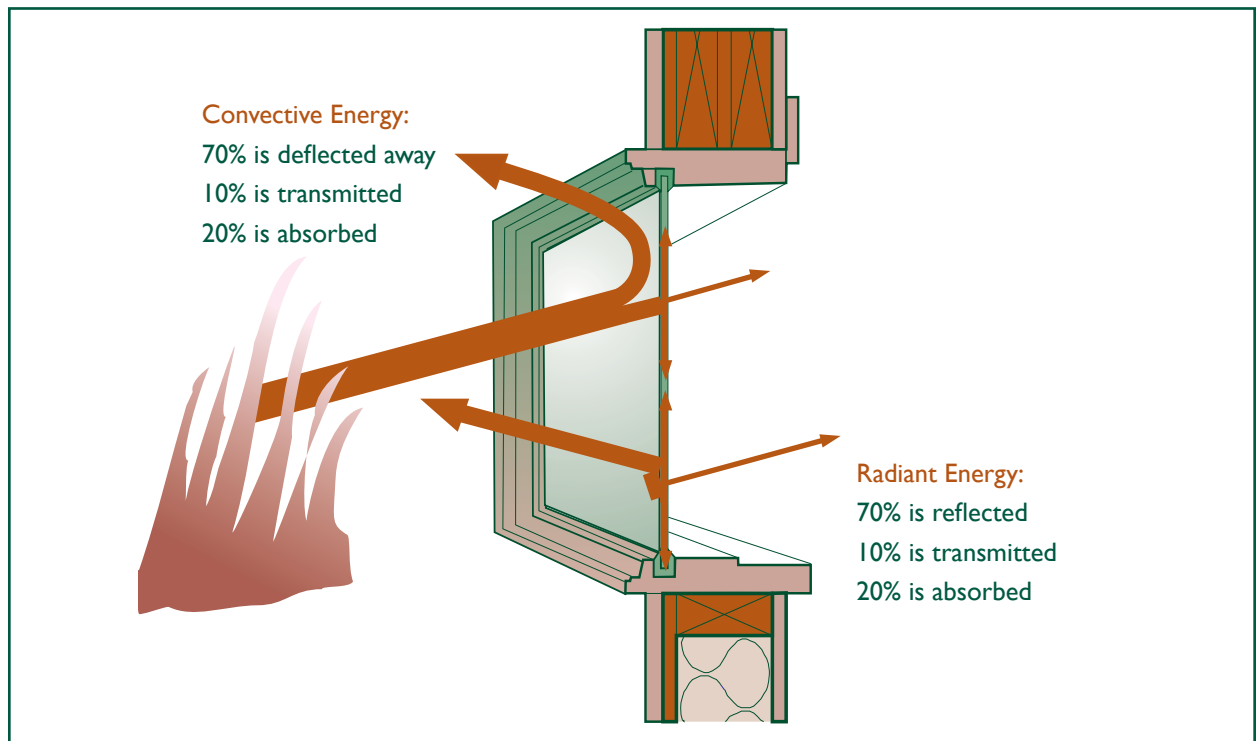

Energy transmission, Low E glass

## Glass block

Glass block is the most fire- resistant glass available. It has the highest available rating of 90 minutes. It has an excellent appearance but provides a poor view. It does not have the Low E option.

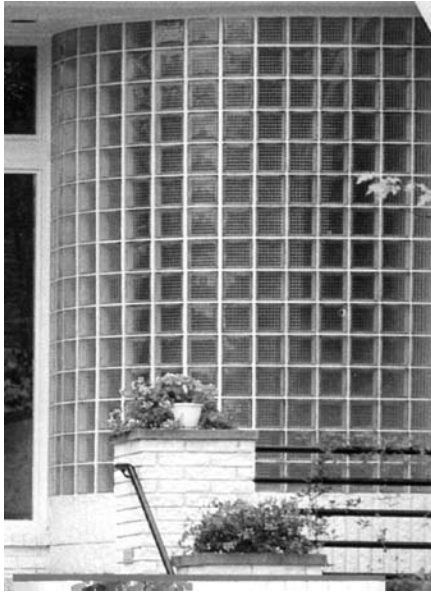

A good use may be in a situation where only day lighting is needed, a view is not a factor and the orientation of the window may be toward a very high fire hazard.

## Frames and sashes

Windows with improved glass technology will only work as long as the glass remains in place. The glass is held in place by the frame, so the frame needs to withstand the fire.

Wood frames will burn. Since they have a high surface-to-volume ratio they will readily ignite and burn freely. They are not a good choice.

Vinyl frames seldom ignite, and if they do, the combustion rate is very slow.

It does not contribute to the combustion of the house. The problem is that vinyl frames melt and structurally fail, allowing the glass to fall away. They are not a good choice either.

Aluminum clad wood frames delay the ignition of the wood frame. They do not completely protect the window because the aluminum conducts the heat to the wood. This delay is enough in most wildland fires.

All aluminum frames are even better. Since there are no combustible materials, they remain fully intact during a fire. These frames are now available with a thermal break, a plastic spine that connects the interior frame to the exterior frame.

## Doors

### Wood doors

Residential buildings typically use wood doors with glass inserts. The same fire issues related to window glass apply to glass in doors. An unrated wood door is typically 1 1/2 to 2 inches thick. It can readily ignite and burn through in only 10 minutes, which is much faster than the rest of the structure will burn.

Wood doors are available with a class C, 20 minute rating. These doors are typically used between the garage and the house. They are a good solution in moderate fire hazard situations. In very high fire hazard situations, they may not resist burning for the fire duration and will allow other exterior building components to ignite.

### Metal doors, steel and aluminum

Metal doors are non-combustible and available with 20 minute, 45 minute and one and one half-hour ratings, which makes them the most appropriate solution for very high hazard situations. Glass sizes are restricted in these doors. The surfaces are available with embossing to simulate wood grain and raised panel designs.

Just as in energy conservation, a good fire-resistive door requires adequate weatherstripping so that the seal prevents hot gasses or burning embers from entering the building.

## 6. Summary

A major wildfire can be an overwhelming event to experience. It can be huge, blotting out the sun and creating its own winds. It can throw flames and burning embers everywhere. Wildfire is a natural part of our environment that we can either respect or fear. If we make adjustments and modifications to our homes and the sites they occupy, then we can live confidently with fire. Each Interface resident must understand the basic characteristics of wildland fire and how it puts their property and lives at risk. Then the actions they take by building appropriate structures and properly caring for their Interface environment can significantly reduce the fire hazard.

A comparison is often made between fire and water. Fire, like water, tries to find a way into our homes. It does not matter how fire-resistant some parts of a structure are if weak points let a fire in. An awareness of how each building component is affected by fire will enable the owner, architect or builder to eliminate those weak points.

And finally, each of us needs to understand that, when we suppress wildland fires we must enhance our forest management policy to reduce fire fuels. When fires do occur they will be more manageable and less destructive to both the forest and our buildings.

### References and additional information

The following is a partial list of publications and/or organizations can provide more information on this topic.

#### *California's I-Zone*

Rodney Slaughter, editor.

Available from the CFESTES bookstore in the California State Fire Marshal's Office, 1131 S St., Sacramento, California 95814.

Ph: 916-445-8200

#### *Brushfire Prone Areas: Siting and Design of Residential Buildings*

##### *Construction of Buildings in Bushfire Prone Areas*

Queensland Department of Local Government and Planning

P.O. Box 187, Brisbane Albert Street Qld 4002, Australia

Ph: 07-3237-1703, Fax: 07-3235-4071

#### *The Urban Wildland Interface Code*

The International Fire Code Institute, International Conference of Building Officials

5360 Workman Mill Road, Whittier, California 90601-2298

Ph: 562-699-0541

#### *NFPA 299 Standard for Protection of Life and Property from Wildfire*

National Fire Protection Association, (NFPA) 11 Tracy Drive, Avon, Massachusetts 02322

Ph. 800-344-3555

[www.firewise.org](http://www.firewise.org)

a web site maintained by NFPA covers much of what is in this pamphlet.